

Ray230 Ray230e

Modular VHF Radio

Owner's Handbook



Raymarine
ON BOARD

RAY230 & RAY230E
Modular
VHF Radio
Owner's
Handbook

Document number: R49006_2
Date: December 2001

Purpose

This handbook contains very important information on the installation, operation, and maintenance of your RAY230 US version or RAY230E European version VHF radio. To get the best results in operation and performance, please take the time to read this handbook thoroughly.

RAY230 US Version

Raymarine radios comply with the Federal Communications Commission (FCC) and Industry Canada requirements that regulate marine VHF radio usage for the US and Canada, respectively.

Marine VHF radio users in the US must comply with all applicable FCC rules and regulations, some of which are described here and in Section 5. This information was current at the time this handbook was printed. Up-to-date information, including licensing requirements, can be obtained on the FCC website at:

www.fcc.gov/wtb/marine

Official FCC forms can be obtained on the FCC website at:

www.fcc.gov/formpage.html

FCC NOTICE

This device complies with Parts 15 and 80 of the FCC Rules. Operation is subject to the conditions that this device does not cause harmful interference. Changes or modifications to this equipment not expressly approved in writing by Raymarine, Incorporated could violate compliance with FCC rules and void the operator's authority to operate the equipment.

Station License

An FCC Ship Radio Station License and Call Sign are not required for most recreational vessels travelling in US waters. Examples of radio equipment that **do not** require a license include: marine VHF radios, any type of Emergency Position Indicating Radio Beacon (EPIRB), any type of radar, GPS or LORAN receivers, depth finders, CB radio, or amateur radio (an amateur license is required). However, you must obtain a license if: (1) you are required by law or treaty to carry a radio on your vessel; (2) your vessel travels to foreign ports; (3) you use marine radio equipment on board your vessel other than the devices listed above. Ships that use MF/HF single side-band radio, satellite communications, or telegraphy must be licensed by the FCC. If necessary, you can obtain a Station License by filing FCC Form 605, which is available from the FCC website listed above.

Operator License

An Operator License is not required to operate a VHF Marine Radio within US territorial waters. However, a license is required to operate the radio if you dock in a foreign port (including Canada and Mexico) or leave a foreign port to dock in a U.S. port. You can request a Restricted Radiotelephone Operator Permit from the FCC by filing Form 753.

Maritime Mobile Service Identity (MMSI)

A nine-digit Maritime Mobile Service Identity (MMSI) number is required to operate the DSC equipment in this radio. You can request an MMSI number from the FCC when you apply for a Station License. If your vessel does not require a license, you may obtain an MMSI by contacting either BoatUS (www.boatus.com) or MariTEL (www.maritelusa.com).

Once obtained, you can program the MMSI number into your RAY230 using the Menu Operation described in this handbook.

INDUSTRY CANADA

You do not need a license to operate this radio within sovereign waters of Canada or the US. You will need a license to operate this radio outside of Canada or the US. To obtain Industry Canada licensing information, contact the nearest field or regional office, or write:

Industry Canada
Radio Regulatory Branch
Attention: DOSP
300 Slater Street
Ottawa, Ontario
Canada, KIA OC8

The following information about the radio is required to complete the license application:

Industry Canada Certification Number	4069823227AD
FCC Type Number	PJ5RAY230
FCC Type Accepted	Parts 15 and 80
Output Power	1 watt (low) & 25 watts (high)
Modulation	16FE (FM)
Frequency Range	156.025-157.425

RAY230E European Version

The RAY230E is a VHF radiotelephone that includes equipment for Class “D” Digital Selective Calling. It is intended for general communication within the Maritime Mobile Service worldwide and is for use on non-SOLAS vessels.

License

Regulations in some areas require that you obtain an operator license before operating VHF radio equipment. It is your responsibility to determine whether a license is required in your area before operating this equipment.

Maritime Mobile Service Identity (MMSI)

An MMSI number is required to operate the Digital Selective Calling (DSC) equipment in this radio. In some areas, a radio operator license is required before an MMSI number will be issued. You can request an MMSI number from the same agency that issues radio operator licenses in your area. You can then program the MMSI number into your RAY230E using the Menu Operation described in this handbook. If regulations in your area do not permit you to program the MMSI number yourself, your Raymarine dealer can program the number for you.

Automatic Transmission Identification System (ATIS)

Your RAY230E can activate the ATIS feature, if needed. You can request an ATIS number from the same agency that issues radio operator licenses in your area. You can then program the ATIS number into your RAY230E using the Menu Operation described in this handbook. If regulations in your area do not permit you to program the ATIS number yourself, you can have your dealer program the number for you. You must only enable this feature when operating the radio in the inland waterways of European countries that require automatic identification transmission.

SAFETY NOTICE

This device is only an aid to navigation. Its performance can be affected by many factors including equipment failure or defects, environmental conditions, and improper handling or use. It is the user's responsibility to exercise common prudence and navigational judgement, and this device should not be relied upon as a substitute for such prudence and judgement.

Your Raymarine VHF radio generates and radiates radio frequency (RF) electromagnetic energy (EME). This equipment must be installed and operated in accordance with the instructions contained in this handbook. Failure to do so can result in personal injury and/or product malfunction.

Antenna Mounting and EME Exposure

For optimal radio performance and minimal human exposure to radio frequency electromagnetic energy, make sure the antenna is:

- connected to the radio before transmitting
- properly mounted
- located where it will be away from people
- located at least three feet (91 cm) from the Base Station transceiver and Handsets

Adjustments or Repair

Adjustments require specialized service procedures and tools only available to qualified service technicians – there are no user serviceable parts or adjustments. The operator should never remove the cover or attempt to service the equipment.

Raymarine products are supported by a network of Authorized Service Representatives. For product information you may contact the following regional centers:

United States Raymarine, Inc.
22 Cotton Road, Unit D
Nashua, NH 03063-4219
USA
Telephone: 603-881-5200
800-539-5539
Fax: 603-864-4756

Europe Raymarine Ltd
Anchorage Park
Portsmouth, Hampshire
England PO3 5TD
Telephone: +44 (0) 23 9269 3611
Fax: +44 (0) 23 9269 4642

Raymarine
ON BOARD

Certificate No.

RT008

EC Declaration of Conformity

We **Raymarine Limited**

**Anchorage Park
Portsmouth
Hampshire
England PO3 5TD**

declare, under our sole responsibility, that the products identified in this declaration, and to which this declaration relates, are in conformity with the essential requirements of European Parliament and Council Directive:

1999/5/EC on radio equipment and telecommunication terminal equipment and the mutual recognition of their conformity.

Product Name:

**Raymarine RAY 230E VHF Radio
with Class "D" DSC**

Product Number(s):

**E43008 (Telular Interface Version)
E43014 (Without Telular Interface Version)**

The products have been assessed to Conformity Procedure Annex IV of the Directive and by application of the following standard(s):

EMC

EN 60945 : 1997

Safety

EN 60945 : 1997

Technical characteristics

EN 301 025 Part 2 and Part 3**EN 300 698 Part 2 and Part 3**

The assessment is consistent with a Technical Construction File showing conformity with the essential requirements of the Directive and has been reviewed by Notified Body No. 0191.

The product is labelled with the CE conformity marking, the identification number of the Notified Body and class identifier.

Signatory:

Name
Title
Company Name
Company Address

**Adil Abbas
EMC Manager
Raymarine Limited
Anchorage Park
Portsmouth, Hampshire
England PO3 5TD**

Signature

Date

24 July 2001

Table of Contents

Section 1 General Description

1.1 Introduction	1-1
1.2 Equipment Features	1-1

Section 2 Installation

2.1 Unpacking and Inspection	2-1
2.2 Equipment Supplied	2-1
2.2.1 Optional Accessories	2-1
2.3 Planning the Installation	2-2
2.4 Electrical Connections	2-4
2.4.1 DC Power and Hailer/NMEA Cable Connections	2-4
2.4.2 Hailer Cable Connections	2-5
2.4.3 NMEA Data	2-6
2.4.4 Using the SeaTalk Auxiliary Junction Box	2-6
2.4.5 Antenna Connections	2-7
2.4.6 Antenna Mounting Suggestions	2-8
2.4.7 Grounding	2-8

Section 3 Operations

3.1 Introduction	3-1
3.2 Control and LCD Display	3-2
3.2.1 Controls	3-2
3.2.2 LCD Display	3-6
3.3 Radio Functions	3-8
3.3.1 RAY230 US Version	3-8
3.3.2 RAY230E European Version	3-9
3.4 Equipment Connections	3-12
3.5 Operating Procedures	3-13
3.5.1 Turning ON/OFF the power supply	3-13
3.5.2 Setting the Volume	3-14
3.5.3 Setting the Squelch	3-14
3.5.4 Using the Function Key	3-14
3.5.5 Setting the Frequency Mode (RAY230)	3-15
3.5.6 Setting the Frequency Mode (RAY230E)	3-16
3.5.7 Receiving the Weather Channels	3-16
3.5.8 Selecting the Channel	3-17
3.5.9 Selecting the Private Channel (RAY230E only)	3-17
3.5.10 Priority Channel (RAY230)	3-18
3.5.11 Priority Channel (RAY230E)	3-18

3.5.12	Multi-Call Operation (RAY230E only)	3-19
3.5.13	Channel Memory	3-19
3.5.14	Setting the Transmission Power Output	3-20
3.5.15	Desensitized Reception (Local Mode)	3-20
3.5.16	LCD Backlight Function	3-20
3.5.17	Hailer Mode	3-21
3.5.18	Fog Alert/Siren Mode	3-21
3.5.19	DTMF Interface Operation	3-23
3.5.20	Intercom Mode	3-23
3.5.21	Scan Mode	3-25
3.5.22	Monitor Mode	3-26
3.5.23	Priority using Multiple Handsets	3-27
3.5.24	NMEA Operation	3-30
3.5.25	Sea Talk Operation	3-32
3.5.26	Digital Selective Calling (DSC)	3-32
3.5.26.1	Individual Call to Ship (Ship-to-Ship)	3-33
3.5.26.2	Individual Call to Shore (Ship-to-Shore)	3-36
3.5.26.3	Receiving an Individual Call	3-38
3.5.26.4	Transmitting a Group Call	3-39
3.5.26.5	Receiving a Group Call	3-40
3.5.26.6	Transmitting an All Ships Call	3-41
3.5.26.7	Receiving an All Ships Call	3-42
3.5.26.8	Transmitting a Distress Call	3-43
3.5.26.9	Receiving a Distress Call	3-47
3.5.26.10	Receiving a Distress Relay Call	3-48
3.5.27	ATIS Operation (RAY230E only)	3-49
3.5.28	Alert Operation	3-49
3.5.30	Menu Operation	3-52
3.5.30.1	Selecting the Menu Operation	3-52
3.5.30.2	NAVSTAT Operation	3-53
3.5.30.3	DSC Operation	3-54
3.5.30.3.1	Selecting Distress Call Type (NATURE)	3-55
3.5.30.3.2	Manual Entry of Latitude/Longitude (L/LENT)	3-56
3.5.30.3.3	Modifying the MMSI Number List (PHNBOOK)	3-58
3.5.30.3.4	Modifying the MMSI Group Number List (GROUP)	3-63
3.5.30.4	Setting Operation (RAY230)	3-65
3.5.30.4.1	Intercom Set Up	3-65

3.5.30.4.2	MMSI Number Set Up	3-67
3.5.30.4.3	Siren Set Up	3-69
3.5.30.5	Setting Operation (RAY230E)	3-71
3.5.30.5.1	Intercom Set Up	3-72
3.5.30.5.2	ATIS Number Set Up	3-72
3.5.30.5.3	MMSI Number Set Up	3-74
3.5.30.5.4	Tri-Watch Set Up	3-75
3.5.30.5.5	ATIS On/Off Set Up	3-76
3.5.30.5.6	Siren Set Up	3-76

Section 4 Maintenance

4.1	How to Contact Raymarine	4-1
4.2	Preventative Maintenance	4-3
4.3	Specifications	4-3
4.4	Drawings	4-7

Section 5 Appendix

5.1	FCC Licensing Requirements	5-1
5.2	Marine VHF Channel Usage Guide	5-3
5.3	Marine VHF Channel Frequency Tables	5-12

Glossary of Terms

All Scan	Scans all channels
ATIS	Automatic Transmission Identification System; used for inland waterways in some European countries
Canadian Channels	Channel designator as defined by Industry Canada
Carrier Wave	A Radio Frequency on which intelligence is superimposed.
DSC	Digital Selective Calling
Dual Watch	Monitor channel 16 while working on another channel
Duplex	Transmit and receive on different frequencies
ETSI	European Telecommunications Standards Institute
FM	Frequency Modulation
International Channels	Channel designator as defined by the ITU
ITU	International Telecommunications Union
LCD	Liquid Crystal Display
Memory Scan	Scans only user selected memory channels
MMSI	Maritime Mobile Service Identity; a number issued by each country to identify maritime stations.
NOAA	National Oceanographic and Atmospheric Administration
PTT switch	Microphone push-to-talk switch
RF	Radio Frequency
RTCM	Radio Technical Commission for Maritime Services
RX	Receiver
Simplex	Transmit and receive on the same frequency
Squelch	A circuit that sets the threshold for cutting off the receiver when the signal is too weak for reception of anything but noise
TX	Transmit
US Channels	Channel designations as defined by the FCC
VHF	Very High Frequency 30MHz to 300MHz
Weather Channels	Channels for routine and emergency weather information broadcast by NOAA

Section 1 General Description

1.1 Introduction

Congratulations on your purchase of Raymarine's RAY230 US version or RAY230E European version fixed-mount marine radiotelephone. In this document, the terms "RAY230/E" and "RAY230/RAY230E" refer to both versions of the radiotelephone.

The RAY230/RAY230E is a microprocessor controlled, digitally synthesized, compact transceiver that provides reliable simplex and semi-duplex (two-frequency) communications. The RAY230/E provides two-way communications on Marine channels and the US version provides reception on 10 separate weather channels. More importantly, the RAY230/RAY230E has built-in Digital Selective Calling (DSC) for sending and receiving DSC Distress, Routine, Safety, and Urgency calls.

1.2 Equipment Features

The RAY230/RAY230E is designed and manufactured to provide ease of operation with excellent reliability. The important built-in features of the equipment are listed below.

- Independent, dedicated receiver for the DSC channel (Channel 70)
- Oversized LCD on the Handset
- Waterproof to U.S.C.G. standard CFR-46 for Base Station Transceiver, Cradle, and External Speaker
- Waterproof to JIS-7 standard for Handset
- Dedicated DISTRESS key on back of Handset
- All solid-state circuitry for low current drain and maximum reliability
- Series relay protection on input power circuits to prevent reverse polarity damage
- High-performance receiver section with optimum selectivity
- Multi-handset (up to 3) operation
- All Scan and Memory Scan features
- Dual/Tri-Watch Monitor modes
- Hailer function
- Intercom operation between handsets
- Distant/local mode
- Optional DTMF interface

Exclusive Features of the RAY230 US Version

- Built-in DSC in accordance with standard SC-101
- Exclusive circuit that automatically selects 16 or 9 as the Priority Channel when the radio is turned on
- Dedicated key for changing the Priority Channel (16/9)
- Exclusive weather alert feature (when in monitor mode)

Exclusive Features of the RAY230E European Version

- ETSI compliant full Class D DSC
- ATIS
- Up to 10 Private Channels
- Multi-call operation

Section 2 Installation

2.1 Unpacking and Inspection

Use care when unpacking the unit from the shipping carton to prevent damage to the contents. It is also good practice to save the carton and the interior packing material. The original packing material should be used in the unlikely event it is necessary to return the unit to the factory.

2.2 Equipment Supplied

The following is a list of materials supplied with the RAY230 and RAY230E:

Description	Part No.
Base Station Transceiver:	
Without DTMF Interface	R49001
With DTMF Interface	R49008
Handset with Cradle:	
RAY230 Full Function Handset	E46009
RAY230E Full Function Handset	E46010
RAY230 External Speaker	R49003
Power/Hailer/NMEA Cable	R49004
Connection Cable, 7m	R49005 ¹
RAY230 & RAY230E Handbook	R49006

¹In most shipments, the R49005 Connection Cable is 7 meters in length and attaches to a 3m-long cable on the handset cradle. Some shipments, however, include a 10m Connection Cable attaching to a 0.35m cable on the handset cradle. The overall length for both cable configurations is approximately 10m.

2.2.1 Optional Accessories

Description	Part No.
RAY230 Second Station (includes Handset, Cradle and Speaker)	E46021
RAY230E Second Station	E46022
Handset Extension Cable, 5m	E46018
Handset Extension Cable, 10m	E46017
External Speaker Extension, 3m	E46015
Hailer Horn Speaker	M95435

2.3 Planning the Installation

When planning the installation of your RAY230/E, the following conditions should be considered to ensure dependable and trouble-free operation.

Mount the Base Station Transceiver, Handset cradle(s), and External Speaker(s) using the Mounting Templates provided.

The Base Station Transceiver is designed to be mounted horizontally or vertically on a flat bulkhead below decks. Select a location that is non-metallic, dry, protected, well-ventilated, and free from high operating temperatures and excessive vibration. Provide sufficient space behind the transceiver to allow for proper cable connections to the rear panel connectors. Locate the transceiver as near as possible to the power source yet as far apart as possible from any devices that may cause interference such as motors, generators, and other on board electronics. The transceiver should be protected from prolonged direct exposure to rain and salt spray.

The transceiver is NOT designed to be mounted in engine compartments. Do NOT install the transceiver in a location where there may be flammable vapors (such as in an engine room or compartment, or in a fuel tank bay), water splash or spray from bilges or hatches, where it is at risk from physical damage from heavy items (such as hatch covers, tool boxes, etc.), or where it might be covered by other equipment.

Locate the Base Station transceiver and Handset at least 3 feet from the antenna.

Mount the primary handset and cradle such that they allow easy access from the location where the ship is normally navigated. By FCC law, the primary handset should be located in the wheel house or in a room adjacent to the wheel house.

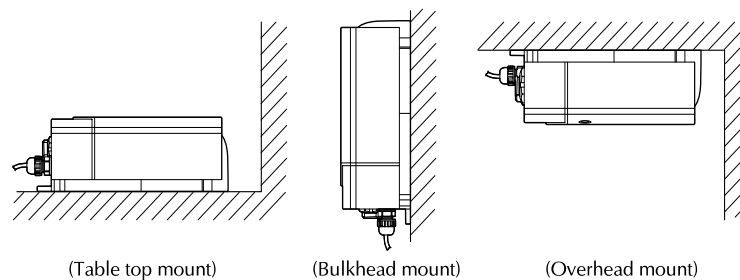
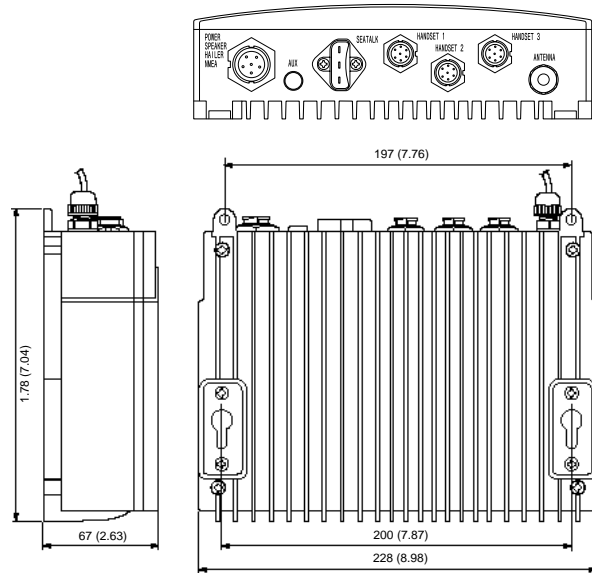
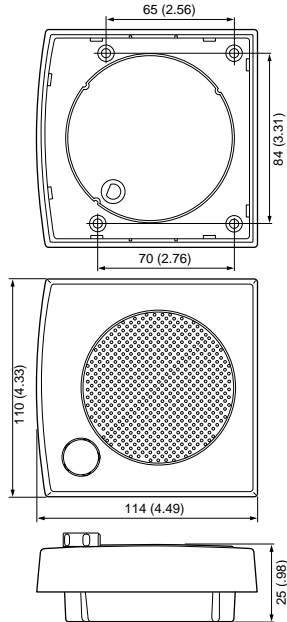

Figure 2-1 Typical Mounting Methods

Base Station Transceiver



External Speaker Unit



Cradle Unit

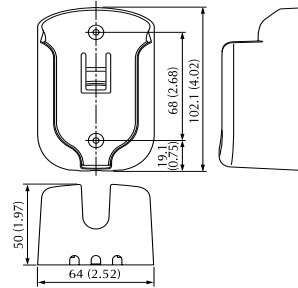

Figure 2-2 Outline and Mounting Dimensions
All dimensions are shown in millimeters and (inches)

2.4 Electrical Connections

2.4.1 DC Power and Hailer/NMEA Cable Connections

The 6-foot-long power cable is a multipurpose assembly containing three wire-pairs for connections to DC power, NMEA input, and the Hailer Horn speaker. Connections to the 6-pin connector are as follows:

Wire Color	Function	Connects to
RED	Power +	Ship's 13.2VDC power
BLACK	Power -	
YELLOW	Hailer +	Hailer Horn speaker
GREEN	Hailer -	
WHITE	NMEA +	Input from position source (GPS)
BLACK	NMEA -	

The RED (+) power wire contains a 10 amp in-line fuse.

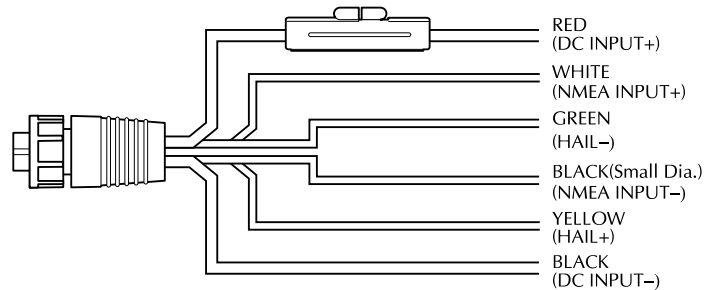

Figure 2-3 Power/Hailer/NMEA Cable and 6-pin Connector

In most cases the length of the power cable should be adequate enough to reach the DC power source. If additional wire length is required, the cable can be extended by adding more cable as necessary. However, for power cable runs longer than 15 feet, larger wire diameter size should be used to prevent voltage line loss.

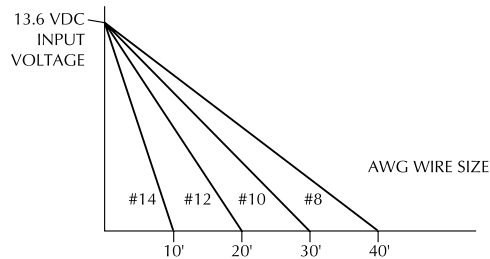

Figure 2-4 Power Cable Length

Your RAY230/E radio should be connected to the nearest primary source of ship's DC power. A typical source may be a circuit breaker on the power panel or a fuse block near the unit. When connecting to either of these sources, the circuit breaker or other in-line fuse should be rated at 10 amps.

It is recommended that lugs be used to connect the power cable to the DC supply and the lug connections should be both crimped and soldered. This is very important in order to ensure adequate current draw to the equipment. If an insufficient connection is made to the power source, the unit may not work properly. The connection terminal should be clean, with no sign of corrosion.

The RED (+) wire is connected to the positive terminal of the power source. The BLACK (-) wire is connected to the negative (ground) of the power source. Should the power connections be inadvertently reversed, the unit will not power up but no damage will occur. Simply check the polarity with a VOM (Voltage/Ohm Meter) and reconnect observing correct polarity. If the fuse ever needs replacement, be sure to use the same type and rating.

2.4.2 Hailer Cable Connections

The YELLOW (+) wire and GREEN (-) wire are used for connecting the RAY230/RAY230E to a Hailer Horn speaker, such as the Raymarine M95435 (Refer to Figure 2-3).

10 watts of audio output power are provided for an external 4 ohm speaker. Connect the YELLOW (+) wire and GREEN (-) wire to the speaker observing polarity as it is marked on the speaker. When connected, the hailer horn speaker will operate in Hailer or Fog modes.

CAUTION: To avoid damage to the radio, DO NOT connect the Hailer GREEN (-) wire to the Hailer YELLOW (+) wire. Also, DO NOT connect the Hailer GREEN (-) wire to the Power BLACK (-) wire.

2.4.3 NMEA Data

The RAY230/E accepts NMEA0183 data from a position determining device (GPS, etc.) to provide the Latitude and Longitude position information that is transmitted during a DSC Distress Call.

Connect the input(s) of the positioning device to the white (NMEA+) and black (NMEA-) wires in the Power/Hailer/NMEA cable.

An example of how to connect the NMEA cables and power supply using a suitable connector block is shown in the diagram below. For specific instructions how to connect your particular GPS, please refer to the handbook that came with that device.

Note: For non-differential GPS, all return connections (-) must be tied to a common ground reference.

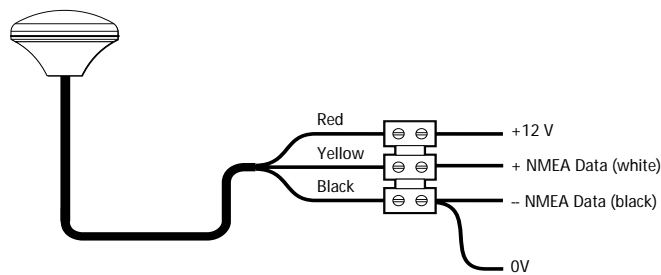

Figure 2-5 Sample GPS Connections to NMEA

2.4.4 Using the SeaTalk Auxiliary Junction Box

If installed, it may be convenient to connect the RAY230/E using the SeaTalk auxiliary junction box. This junction box enables the SeaTalk bus, power, and GPS to be connected.

If power is not already available (via another SeaTalk instrument), the junction box can be used to apply power to the SeaTalk bus for other applications. The junction box may also be used for connecting an NMEA GPS system.

The junction box includes:

- SeaTalk cable and connector to attach to display unit
- Power cable to connect to 12 V power (if required)
- Input connections to connect SeaTalk cable from external equipment
- Spare connections for another instrument

The illustration below shows how to connect the junction box.

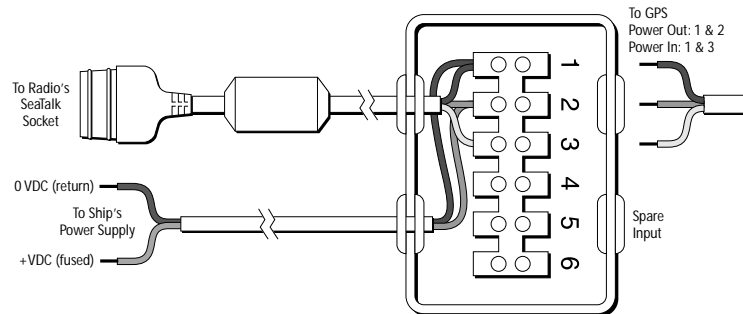

Cable	Core	Terminal	Function
SeaTalk	Black (screen)	1	0V
	Red	2	+12v
	Yellow	3	SeaTalk
Power	Black (screen)	1	0V
	Red	2	+12V
GPS	Black (screen)	1	0V
	Red	2	+12V
	Yellow	3	SeaTalk

Figure 2-6 SeaTalk Junction Box Connections

2.4.5 Antenna Connections

Your coaxial VHF antenna cable connects to the RAY230/E antenna cable on the rear panel using a PL259 VHF type connector. Your VHF antenna cable can be cut to length but the overall cable length can be critical to performance. If you are uncertain, contact a professional installer or call Raymarine Customer Service. If a longer cable length is required, RG-58 (50 ohm) coaxial cable or equivalent cable can be used for runs up to a maximum of 50 feet. If the distance required is even greater, we recommend using low loss RG-213 or equivalent cable for the entire run to avoid excessive losses in power output.

If the antenna RF connector is likely to be exposed to the marine environment, a protective coating of grease (Dow Corning DC-4 or similar) can be applied to the connector before connecting it to the radio. Any other extensions or adapters in the cable run should also be protected by silicon grease and then wrapped with a waterproofing tape.

2.4.6 Antenna Mounting Suggestions

The best radio in the world is useless without a quality antenna and good location. Mounting the VHF antenna properly is very important because it will directly affect the performance of your VHF radio. A VHF antenna designed for marine vessels should be used.

- Since VHF transmission is essentially line-of-sight, mount the antenna at the highest possible location on the vessel and free of obstruction to obtain maximum range.
- If you must extend the length of the coaxial cable between the antenna and the radio, use a coaxial cable designed for the least amount of power loss over the entire cable length.

2.4.7 Grounding

It is good marine practice to properly ground your VHF radiotelephone, as well as all other electronic equipment, to the ship's ground system.

One of the mounting tabs on the edge of the base station transceiver has been designated for this purpose. See Figure 2-7 below. After the base station has been mounted, you should ground the unit by attaching a wire to the screw inserted through the tab labeled "GND". Then connect this wire to the nearest ship's ground connection point. The recommended wire to be used for such grounding is #10 AWG.

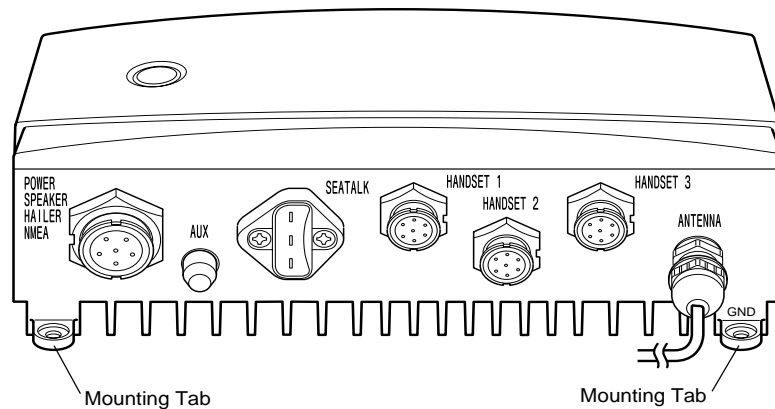

Figure 2-7 Typical Grounding Method

Section 3 Operations

3.1 Introduction

The RAY230 has the capability to transmit and receive on all available US, Canadian, and International Marine VHF radiotelephone channels. The RAY230E can transmit and receive on all available International and US Marine VHF radiotelephone channels. There are channels that are FCC approved but may only be used by authorized stations for specific purposes, depending on the type of vessel (commercial or non-commercial.) Refer to Section 5.3, which lists all marine VHF channels available in your RAY230/RAY230E for US, International and Canadian radiotelephone use. You should familiarize yourself with these tables to ensure you use the proper channels.

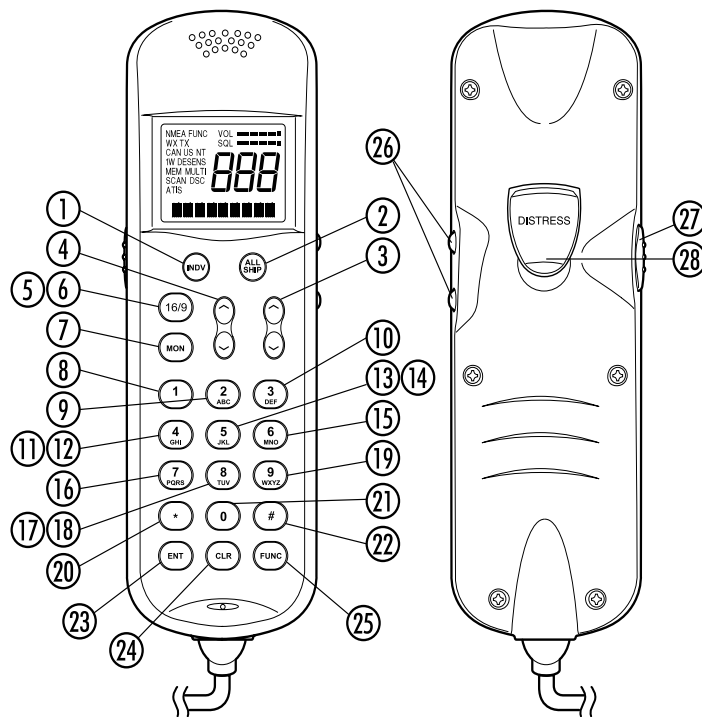

Figure 3-1 Layout of Controls

3.2 Controls and LCD Display

3.2.1 Controls

① **INDV key**

Switches to the DSC Individual Ships Call mode for initiating ship-to-ship or ship-to-shore calls using a specific MMSI number. Descriptions of these operations appear below in sections 3.5.26.1 and 3.5.26.2.

Note: *An MMSI number is required to operate the DSC equipment in this radio. You can program the MMSI number yourself one time only using the Menu Operation described in section 3.5.30.4.2 or you can have your Raymarine dealer program the number for you.*

② **ALL SHIP key**

Switches to the All Ships Call mode for Safety and Urgency transmissions. Descriptions of subsequent operations appear below in section 3.5.26.5 Transmitting All Ships Call.

③ **SQ UP/DOWN (SCROLL) key**

Increases or decreases the squelch sensitivity. Pressing the UP \wedge key increases the squelch, while the DOWN \vee key decreases it. The number of segments in the SQ bar graph on the LCD display will increase or decrease accordingly. This key is also used as a scroll key for selecting menu items and other settings, as described below.

④ **VOL UP/DOWN key**

Changes the sound volume of the handset. Pressing the UP \wedge key increases the volume, while the DOWN \vee key causes it to decrease. The number of segments in the VOL bar graph on the LCD display will increase or decrease accordingly.

⑤ **16/9/POWER key (RAY230 US version only)**

Switches between the Working Channel and the Priority Channel. Pressing and holding the key for 2 seconds alternates the Priority Channel between channel 9 and channel 16. When the transceiver's main power switch is turned on, this key is also used to power the system ON or OFF.

⑥ **16/POWER key (RAY230E European version only)**

Switches between the Working Channel and Channel 16 (the Priority Channel). When the transceiver's main power switch is turned on, this key is also used to power the system ON or OFF.

- ⑦ **MON/TRI key**
Starts the Dual-Watch monitor mode. Pressing the FUNC key followed by the MON/TRI key initiates the Tri-Watch monitor mode.
- ⑧ **1/MEM key**
This key inputs the number 1. When an alphanumeric response is appropriate, this key alternates between entering a 1 and a space. If the channel number indicated on the LCD display is not currently stored in memory, pressing the FUNC key followed by the 1/MEM key enters that channel number into memory. If the currently indicated channel has already been stored, pressing the FUNC key followed by the 1/MEM key deletes that channel from memory.
- ⑨ **2/SCAN key**
This key inputs the number 2. When an alphanumeric response is appropriate, each press of this key alternately inputs the characters 2, A, B, then C. Pressing the FUNC key followed by the 2/SCAN key toggles Scan mode ON or OFF. Scan mode is described below in Section 3.5.21.
- ⑩ **3/CELL key**
This key inputs the number 3. When an alphanumeric response is appropriate, each press of this key alternately inputs the characters 3, D, E, then F. Pressing the FUNC key followed by the 3/CELL key connects the handset with any auxiliary communication equipment with DTMF interface (RAYCOM Cellular, Mini-M, etc.) connected to the AUX port at the rear of the transceiver. See section 3.5.19.
- ⑪ **4/INT key (RAY230 only)**
This key inputs the number 4. When an alphanumeric response is appropriate, each press of this key alternately inputs the characters 4, G, H, then I. Pressing the FUNC key followed by the 4/INT key alternates the frequency groups from US mode to International mode to Canadian mode.
- ⑫ **4/US key (RAY230E only)**
This key inputs the number 4. When an alphanumeric response is appropriate, each press of this key alternately inputs the characters 4, G, H, then I. Pressing the FUNC key followed by the 4/US key alternates the frequency groups between US mode and International mode.

Note: Access to the US frequency group is only available with a software upgrade from your dealer. Otherwise this feature is disabled.

- ⑬ **5 key (RAY230 only)**
This key inputs the number 5. When an alphanumeric response is appropriate, each press of this key alternately inputs the characters 5, J, K, then L.
- ⑭ **5/PRIV key (RAY230E only)**
This key inputs the number 5. When an alphanumeric response is appropriate, each press of this key alternately inputs the characters 5, J, K, then L. Pressing the FUNC key followed by the 5/PRIV key switches to the Private Channel mode. To select the desired Private Channel, press the FUNC key followed by the 5/PRIV key, then input the number key(s) corresponding to the desired channel number and press ENT.
- ⑮ **6/WX key**
This key inputs the number 6. When an alphanumeric response is appropriate, each press of this key alternately inputs the characters 6, M, N, then O. Pressing the FUNC key followed by the 6/WX key alternates between the Working Channel and the Weather Channel. For the RAY230E European model, this operation is valid only in US frequency mode.
- ⑯ **7/D/L key**
This key inputs the number 7. When an alphanumeric response is appropriate, each press of this key alternately inputs the characters 7, P, Q, R, then S. Pressing the FUNC key followed by the 7/D/L key toggles between full receiver sensitivity (distant mode) and attenuated receiver sensitivity (local mode). Local mode is used in high traffic areas to decrease unwanted reception. While in local mode (receiver is desensitized), the DESENS indicator appears in the LCD display.
- ⑰ **8 key (RAY230 only)**
This key inputs the number 8. When an alphanumeric response is appropriate, each press of this key alternately inputs the characters 8, T, U, then V.
- ⑱ **8/M-CALL key (RAY230E only)**
This key inputs the number 8. When an alphanumeric response is appropriate, each press of this key alternately inputs the characters 8, T, U, then V. Pressing the FUNC key followed by the 8/M-CALL key starts Multi-Call mode. If the key is pressed during Multi-Call mode, the operation returns to normal mode.

- ⑲ **9/ 1/25 key**
This key inputs the number 9. When an alphanumeric response is appropriate, each press of this key alternately inputs the characters 9, W, X, Y, and then Z. Pressing the FUNC key followed by the 9/1/25 key alternates the transmission power between 1W and 25W.
- ⑳ ***/HAIL key**
This key inputs an asterisk (*). Pressing the FUNC key followed by the */HAIL key initiates the Hailer mode, which enables a Hailer Horn speaker to be used as a loud speaker or a directional microphone. Pressing the FUNC key followed by this key during Hailer mode returns operation to normal mode.
- ㉑ **0/IC key**
This key inputs the number 0. Pressing the FUNC key followed by the 0/IC key starts Intercom mode, which enables conversation between handsets. Pressing the FUNC key followed by this key during Intercom mode returns operation to normal mode.
- ㉒ **#/FOG key**
This key inputs the # character. Pressing the FUNC key followed by the #/FOG key initiates the Fog Alert mode, which enables a Hailer Horn speaker to sound several types of automatic or manual alert tones. Pressing the FUNC key followed by this key during Fog mode returns operation to normal mode.
- ㉓ **ENT/MENU key**
This key performs the Enter function. It is used to confirm and implement an input action. Pressing the FUNC key followed by the ENT/MENU key initiates the Menu mode.
- ㉔ **CLR/LOG key**
Depending on when it is used, this key exits the current mode and reverts to the last used mode or normal operation. This key also can be used to clear any alphanumeric inputs one at a time in the order that they were entered. Pressing the FUNC key followed by CLR/LOG key initiates the Digital Selective Calling (DSC) Log. Pressing the key during logging returns operation to normal mode.
- ㉕ **FUNC/DIM key**
Initiates the Function mode and activates the FUNC indicator in the LCD display. The next key pressed determines the function selected. (See above key descriptions.) Pressing this key twice starts Dimmer mode, which reduces the brightness of LCD's backlight.

- ②⑥ **Channel UP/ DOWN switch**
Pressing this switch during normal operation changes the channel number UP or DOWN.
- ②⑦ **PTT (Press-to-Talk) switch**
Pressing this switch during normal operation places the radio in Transmit mode and displays the TX indicator in the LCD. When the switch is pressed in various function modes, the assigned operation is initiated.
Note: After 5 minutes of continuously holding the PTT switch, the radio will automatically stop transmitting. To begin transmitting again, release the PTT and depress again.
- ②⑧ **DISTRESS switch**
This switch is located under the small door labeled DISTRESS on the back of the handset. Pressing and holding this switch for 4 seconds selects Distress Signal Call mode. Subsequent operations are described in section 3.5.26.7.

3.2.2 LCD Display

The following describes the functional characters on the RAY230/RAY230E Handset's LCD.

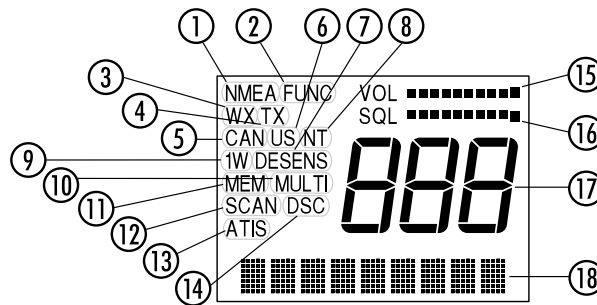

Figure 3-2 LCD Display Layout

- ① **NMEA indicator**
Displayed when the radio receives valid SeaTalk or NMEA position data. If the data is invalid or no data is received for a period of time, the indicator disappears.

- ② **FUNC indicator**
Displayed when the FUNC key is pressed. Disappears when another key is pressed, or after no other key is pressed for a period of time.
- ③ **WX indicator**
Displayed while in Weather Channel mode. For the RAY230E, this indicator only appears in the US frequency mode, if this feature has been activated.
- ④ **TX indicator**
Displayed while transmitting.
- ⑤ **CAN indicator (RAY230 only)**
Displayed when the Canadian frequency group is selected.
- ⑥ **US indicator**
Displayed when the US frequency group is selected.
- ⑦ **DESENS indicator**
Displayed during the desensitized receiving (local) mode.
- ⑧ **INT indicator**
Displayed when the International frequency group is selected.
- ⑨ **1W indicator**
Displayed when the transmission power of 1W is selected with the 9/1/25 key or when a low power channel is selected.
- ⑩ **MULTI indicator (RAY230E only)**
Displayed while the channel stored in Multi-Call memory is displayed.
- ⑪ **MEM indicator**
Displayed while the channel stored in memory is displayed. This indicator flashes before the start of the memory scan operation.
- ⑫ **SCAN indicator**
Displayed during Scan mode. If channels have been stored in memory, this indicator will be flashing before the start of Scan mode.
- ⑬ **ATIS indicator (RAY230E only)**
Displayed when the ATIS (automatic identification transmission) feature is turned on (via Menu mode).
- ⑭ **DSC indicator**
Displayed when in a Digital Selective Calling (DSC) call mode, DSC log, or the DSC menu.

- ⑮ **VOL indicator (in bar graph)**
Represents the current sound volume level of the handset. A louder volume displays a larger number of segments in the bar graph. This bar graph is not displayed during Menu mode.
- ⑯ **SQL indicator (in bar graph)**
Represents the current squelch level. A deeper squelch displays a larger number of segments in the bar graph.
- ⑰ **Three-digit, Seven-segment indicators**
Display the channel number or state of the radio.
- ⑱ **Nine-digit Dot-matrix display**
Displays alphanumeric messages, modes, and functional status of the radio.

3.3 Radio Functions

3.3.1 RAY230 US Version

1. **Selecting the Frequency Mode**
Channel selection is available from among three frequency groups: US, International, or Canadian.
2. **Receiving the Weather Channels**
The RAY230 is programmed to receive 10 NOAA weather channels and will sound an alarm if a Weather Alert is received.
3. **Selecting the Priority Channel**
Select Channel 16 or Channel 9 as the Priority Channel.
4. **Dimmer Operation**
Select from four LCD backlight levels, including OFF.
5. **Monitor Operation**
Select from Dual-Watch or Tri-Watch mode.
6. **Scan Operation**
Select from All Scan or Memory Scan.
7. **Selecting Transmission Power Output**
Select either 1W or 25W for the transmission power.
8. **Digital Selective Calling (DSC) Operation**
Conforms to the SC-101 standard for a VHF DSC radio. These functions include Individual Ships Call, All Ships Call, Distress Call, Group Call, and DSC logging capability.

Note: An MMSI number is required to operate the DSC equipment in this radio. You can program the MMSI number yourself one time only using the Menu Operation described in section 3.5.30.4.2 or you can have your Raymarine dealer program the number for you.

9. NMEA Receiving Operation

Positional information from external equipment is obtained using the NMEA 0183 interface.

10. SeaTalk Operation

Position data from other Raymarine equipment is obtained using the SeaTalk line.

11. Remote Operation

Up to three full function handsets can be connected to the RAY230. Auxiliary handsets can be housed in the cradle, enabling you to listen to radio reception from the external speaker.

12. Intercom Function between Handsets

The Intercom function is available when two or more handsets are connected.

13. Desensitized Reception (Local Mode)

This function decreases receiver sensitivity in high traffic areas to decrease unwanted reception.

14. Hailer Operation

The Hailer Horn speaker can be used as a loud speaker or a directional microphone.

15. Fog Horn Operation

The Hailer Horn speaker can sound several types of fog alerts.

16. DTMF Interface Operation (Optional)

If this optional feature has been installed, the handset can be used as an interface to any DTMF formatted communications device by connecting that device to the AUX terminal. See section 3.5.19.

3.3.2 RAY230E European Version

1. Selecting the Frequency Mode

Channel selection is available from two frequency groups: US and International. In the US mode, the radio only has access to US channels.

Note: Access to the US frequency group is only available with a software upgrade from your dealer.

- 2. Private Channel Operation**

If you are licensed to do so, you can program up to ten Private Channels.
- 3. Multi-call Operation**

The Multi-Call function stores your favorite channels in memory for quick access.
- 4. Weather Channel Access Operation**

The RAY230E is programmed to receive 10 NOAA weather channels and sounds an alarm if a Weather Alert is received. This operation is available only in US frequency mode, if this mode has been activated in your unit.
- 5. Channel Memory Operation**

Channels that are stored in memory in the same frequency group can be scanned using the Memory Channel Scan function.
- 6. Priority Channel Operation**

Channel 16 is designated as the Priority Channel.
- 7. Dimmer Operation**

Select from four LCD backlight levels, including OFF.
- 8. Monitor Operation**

Select from Dual-Watch or Tri-Watch mode.
- 9. Scan Operation**

Select from All Scan or Memory Scan.
- 10. Selecting Transmission Power Output**

Select either 1W or 25W for the transmission power.
- 11. Digital Selective Calling (DSC) Operation**

This operation conforms to EN 301 025 Parts 2 and 3 and EN 301 698 Parts 2 and 3, in accordance with ITU-RM493. These functions include Individual Ships Call, All Ships Call, Distress Call, Group Call, and DSC logging capability.

Note: *An MMSI number is required to operate the DSC equipment in this radio. You can program the MMSI number yourself one time only using the Menu Operation described in section 3.5.30.4.2 or you can have your Raymarine dealer program the number for you.*
- 12. NMEA Receiving Operation**

Positional information from external equipment is obtained using the NMEA 0183 interface.

13. ATIS Operation

When operating in inland waterways, many European countries require automatic identification transmission, in accordance with ETS300 698. The RAY230E has the capability of activating this ATIS function. This radio is also equipped with “ATIS Killer” to squelch unwanted electrical noise associated with ATIS transmissions.

14. SeaTalk Operation

Position data from other Raymarine equipment is obtained using the SeaTalk line.

15. Remote Operation

Up to three full function handsets can be connected to the RAY230E. Auxiliary handsets can be housed in the cradle, enabling you to listen to radio reception from the external speaker.

16. Intercom Function between Handsets

The Intercom function is available when two or more handsets are connected.

17. Desensitized Reception (Local Mode)

This function decreases receiver sensitivity in high traffic areas to decrease unwanted reception.

18. Hailer Operation

The Hailer Horn can be used as a loud speaker or a directional microphone.

19. Fog Horn Operation

The Hailer Horn speaker can sound several types of manual and auto fog alerts.

20. DTMF Interface Operation (Optional)

If this optional feature has been installed, the handset can be used as an interface to any DTMF formatted communications device by connecting that device to the AUX terminal. See section 3.5.19.

3.4 Equipment Connections

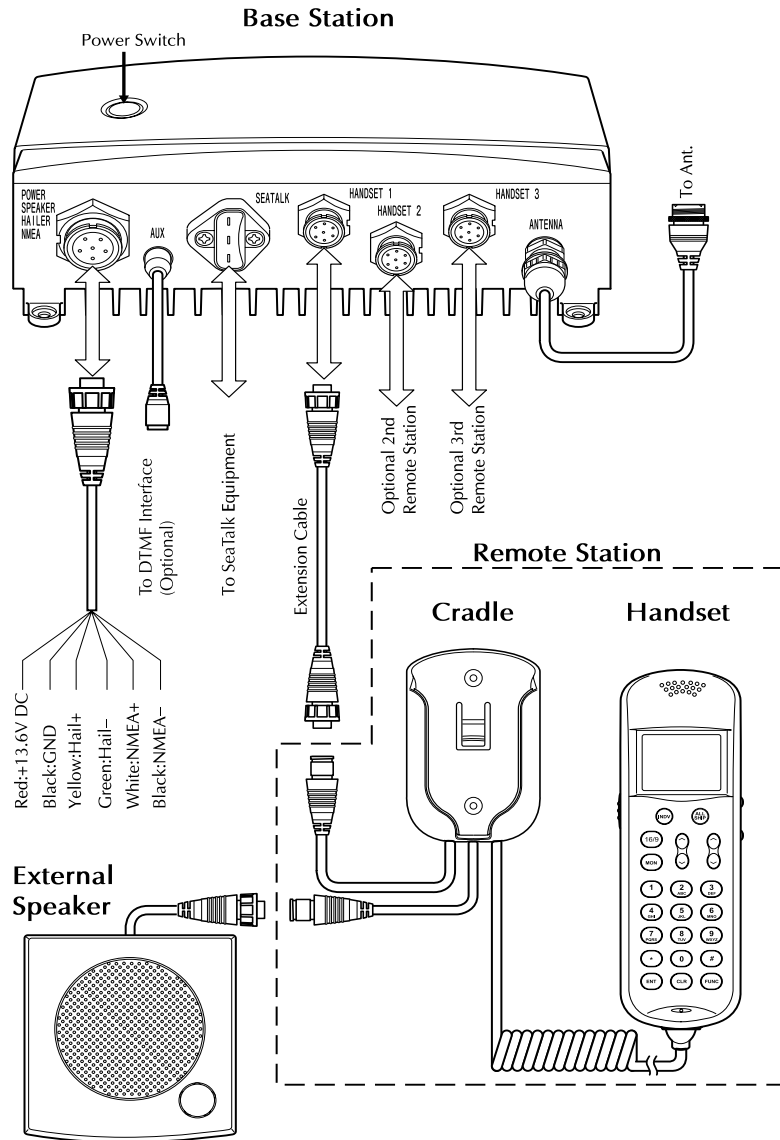

Note: Before the radio can recognize that a handset has been plugged into any of the three HANDBOOK ports, you must cycle the base station OFF and ON again, even if only moving the handset from one port to another.

3.5 Operating Procedures

With the RAY230 and RAY230E, all operations are made on the Handset except turning ON/OFF the main power supply and adjusting the sound volume of the External Speaker.

3.5.1 Turning ON/ OFF the Power Supply

To power on the RAY230/E:

1. Press the POWER switch on the base station transceiver (main unit). A light illuminates the button when power is ON. The main unit and the handset(s) are placed in a standby power condition, drawing about 150 mA. The radio circuitry does not yet have power.
2. Press the 16/9/POWER key (RAY230) or 16/POWER key (RAY230E) on any handset. The full system is then powered ON.

You must press POWER on the base station and the 16/9/POWER or 16/POWER button on the handset to fully power on the radio.

Notes:

- *If the main power supply switch is OFF, the handsets cannot power the system ON.*
- *If the main power supply switch is ON and multiple handsets are connected, pressing the FUNC and 16/9/POWER key (16/POWER key for the RAY230E) from one handset will fully power ON the system and all handsets.*

To power off the RAY230/E:

1. Press the FUNC key followed by the 16/9/POWER key (RAY230) or 16/POWER key (RAY230E) on any handset. The main unit and all handset(s) return to the standby condition.
2. Press the POWER switch on the base station transceiver. The light illuminating the button goes out. Full system power is OFF.

Note: *If multiple handsets are connected, initiating power OFF from one handset will cause all the handsets (and main unit) to enter the standby condition.*

When ship's power is removed then returned to the base station, the unit returns to its last state. For example, if the POWER switch was left in the ON position, the base station will be ON when power is restored.

You must still press the 16/ POWER or 16/9/POWER button to power on the handsets.

3.5.2 Setting the Volume

Setting the Volume on the Handset

The sound volume adjustment for the handset has 11 settings. Pressing and releasing the VOL UP \wedge key increases the volume by one level; pressing and releasing the VOL DOWN \vee key reduces the volume by one level.

The number of segments in the VOL bar graph on the LCD display will increase or decrease accordingly. If the VOL UP/DOWN keys are pressed and held, the volume levels will automatically change every half-second.

Setting the Volume on the External Speaker

The volume knob on the External Speaker controls its sound volume. Turning the knob clockwise increases the volume; turning it counterclockwise reduces the volume. Turning the knob fully counterclockwise until you hear a "click" switches off the speaker completely.

The external speaker sounds alert tones, such as Distress calls, at maximum volume regardless of the volume set with the knob, even when the knob is set to the OFF position.

3.5.3 Setting the Squelch

The squelch adjustment enables you to "quiet" the receiver when no signal is being received. The squelch adjustment for the handset has 11 settings. Pressing and releasing the SQ UP \wedge key increases the squelch by one level; pressing and releasing the SQ DOWN \vee key decreases it by one level. The number of segments in the SQ bar graph on the LCD display will increase or decrease accordingly. If the SQ UP/DOWN keys are pressed and held, the squelch levels will automatically change every half-second.

3.5.4 Using the Function Key

Most of the keys on the handset control multiple operations. Pressing one of these keys after pressing the FUNC key initiates the operation marked on the label above that key. When the FUNC key is pressed, the FUNC indicator is displayed on the LCD display. If no other key is pressed for 5 seconds, the Function operation is cancelled and the FUNC indicator disappears.

3.5.5 Setting the Frequency Mode (RAY230)

Select the channel frequency group to be used: US, International, or Canadian. Indicators displayed in the LCD identify the active frequency group: US for the US frequency group, INT for the International group, and CAN for the Canadian group.

Changing the Frequency Group

Pressing the FUNC key followed by the INT key alternates the frequency groups from US mode to International mode to Canadian mode then back to US mode. When the power supply is turned on, the radio is initiated on the last selected Priority Channel (9 or 16) in the frequency group last selected.

When the frequency group is changed, the channel number remains the same as was selected in the previous group, as long as that number is present in the new group. If a channel number is absent in the destination group, the new channel will be the previous number plus 1. When returning to the previous frequency group, the channel returns to its original number if the channel has not been changed. If the channel has been changed, that number is retained when the frequency group is changed.

Example 1

CH15 US \Rightarrow CH15 INT \Rightarrow CH15 CAN \Rightarrow CH15 US

When shifting the frequency group, the channel remains the same because the corresponding channel number exists in the new frequency group.

Example 2

CH2 CAN \Rightarrow CH3 US \Rightarrow CH2 INT \Rightarrow CH2 CAN

No corresponding channel exists in the new frequency group, so the channel is incremented by 1. As long as the channel is not changed further, it returns to its previous number if the frequency group is again changed.

Example 3

CH2 CAN \Rightarrow CH3 US, then changed to CH5 \Rightarrow CH5 INT \Rightarrow CH5 CAN

However, if the channel is changed in the new frequency group, this new number is retained when the frequency group is changed.

3.5.6 Setting the Frequency Mode (RAY 230E)

Select the channel frequency group to be used from either US or International. Indicators displayed in the LCD identify the active frequency group: US for the US frequency group or INT for the International group.

Note: *Access to the US frequency group is only available with a software upgrade from your dealer. You may also need to obtain an Operator License from the FCC, which is required for operating a VHF marine radio within US territorial waters if you dock in a foreign (non-US) port or leave a foreign port to dock in a US port.*

Changing the Frequency Group

Pressing the FUNC key followed by the US key alternates the frequency groups from US mode to International mode then back to US mode. When the power supply is turned on, the radio initially operates on Channel 16 in the frequency group last selected.

When the frequency group is changed, the channel number remains the same as was selected in the previous group, as long as that number is present in the new group. If a channel number is absent in the destination group, the new channel will be the previous number plus 1. When returning to the previous frequency group, the channel returns to its original number if the channel has not been changed. If the channel has been changed, that number is retained when the frequency group is changed.

Refer to the examples in section 3.5.5 above, ignoring the references to the Canadian frequency group.

3.5.7 Receiving the Weather Channels

The Weather Channels consist of Channel 0 through Channel 9. To switch between the Working Channel and the current Weather Channel, press the FUNC key followed by the 6/WX key. While the Weather Channel is active, the WX indicator appears in the LCD display and the frequency group indicator disappears.



If the channel number is changed while in the Weather mode, the new channel number is stored in memory upon exiting Weather mode. To exit Weather Mode, press CLR, or FUNC followed by 6/WX.

Note: *On the RAY230E, this feature requires separate software upgrades for access to the US frequency group and to the weather channels.*

3.5.8 Selecting the Channel

Two methods are available for selecting the channel: inputting the channel with the numeric keypad then pressing the ENT key or using the Channel UP/DOWN switch on the side of the handset. Both methods are applicable to the three frequency groups on the Working Channel.

Using the Channel UP/DOWN Switch

Pressing the Channel UP  switch increments the current channel number by one for each key-click. When the highest channel number is reached, the channel scrolls to the lowest number and increments from there. Pressing the Channel DOWN  switch decrements the current channel number by one for each key-click. When the lowest channel number is reached, the channel scrolls to the highest number and decrements from there. Channel numbers not available in a particular frequency group are skipped.

If the Channel UP/DOWN switch is pressed and held for at least a half second, channels automatically change every 100 milliseconds.

Using the Numeric Keypad

To select a channel, input the desired number on the keypad. For 5 seconds the channel number flashes on the LCD display. If the ENT key is pressed during this 5 second interval, the channel change is implemented. If the 5 seconds elapse without pressing another key, the channel change is implemented anyway. If the CLR key is pressed while the number is flashing, the channel returns to the previous number.

Note: *A leading zero is required for single digit channel numbers.*

3.5.9 Selecting the Private Channel (RAY230E only)

To select the Private Channel, press the FUNC key, followed by the 5/PRIV key, then input the channel number on the keypad. For 5 seconds the channel number flashes on the LCD display. If the ENT key is pressed during this flashing phase, the channel change is implemented. If the 5 seconds elapse without pressing another key, the channel change is implemented. If the CLR key is pressed during the flashing phase, the channel returns to the previous number.

Note: *While using the Private Channel, selecting a new Working Channel or pressing the CLR key returns operation to the Working Channel.*

The RAY230E has ten Private Channels (P1–P10) available. However, only certain Private Channels can be used within each country. The following table lists which channels have been allocated for use within your country.

Country	Private CH No.	Channel Designator	Frequency TX/RX (MHz)	Channel Use
UK	P1	M1/37C	157.850/157.850	Pleasure Boat
	P2	M2	157.850/157.850	Pleasure Boat
Denmark	P3	L1	155.500/155.500	Pleasure Boat
	P4	L2	155.525/155.525	Pleasure Boat
Finland, Norway & Sweden	P3	L1	155.500/155.500	Pleasure Boat
	P4	L2	155.525/155.525	Pleasure Boat
	P5	L3	155.650/155.650	Pleasure Boat
Netherlands	P6	31A	157.550/162.150	
Belgium	P6	31A	157.550/162.150	
Denmark,	P8	F1	155.625/155.625	Fishing Boat
Finland,	P9	F2	155.775/155.775	Fishing Boat
Norway & Sweden	P10	F3	155.825/155.825	Fishing Boat

Note: *It is your responsibility to obtain the proper license to operate the radio on these frequencies.*

3.5.10 Priority Channel for RAY230

In the RAY230 US version, the Priority Channel operates on either Channel 16 or Channel 9. Pressing the 16/9 key during any operation except the Distress Call switches to the Priority Channel. Pressing and holding the 16/9 key for 2 seconds alternates the Priority Channel between Channel 16 and Channel 9.

While using the Priority Channel, pressing the 16/9 key or the CLR key returns operation to the Working Channel.

3.5.11 Priority Channel for RAY230E

In the RAY230E European version, the Priority Channel operates on Channel 16. Pressing the 16 key at any state except the Distress Call shifts operation to the Priority Channel. While using the Priority Channel, pressing the 16 key or the CLR key returns operation to the Working Channel.

3.5.12 Multi-Call Operation (RAY230E only)

The Multi-Call function stores your favorite channels in memory for quick access. If you have had optional access to the US frequency group installed, separate Multi-Call channels are available for both the US and International frequency groups. When the frequency group is changed, the radio operates the channels registered in the previous Multi-Call.

Using Multi-Call

To start the Multi-Call operation, press the FUNC key followed by the 8/M-CALL key. The Multi-Call channel used in the previous operation is displayed. Use the Channel UP/DOWN key to increment/decrement through the Multi-Call channels in memory. When exiting Multi-Call, the last-used channel is stored to be used the next time Multi-Call starts.

Changing from the Multi-Call Channel to the Working Channel

During the Multi-Call operation you can return to the Working Channel by again pressing FUNC followed by 8/M-CALL, by pressing the CLR key, or by entering the channel number directly with the ENT key.

Storing the Multi-Call Channel

From the Working Channel mode, select the channel to be stored. Press and release the FUNC key then press and hold the 8/M-CALL key for 3 seconds. The MULTI indicator appears when the registration is complete.

If you attempt to store either a Weather Channel or a Private Channel as a Multi-Call channel, the registration is terminated and an error alert tone sounds.

Deleting a Channel from Multi-Call

From the Working Channel mode, select the channel to be deleted. Press and release the FUNC key then press and hold the 8/M-CALL key for 3 seconds. The MULTI indicator disappears when the channel has been deleted.

3.5.13 Channel Memory

Channels that are stored in memory in the same group can be scanned using the Memory Channel Scan function. Channels can be stored in memory for each frequency group; when the frequency group is changed, the radio operates according to the channels stored in memory for that group.

Storage in memory of Weather Channels or the Private Channels is disabled. When storage of these channels is attempted, the registration is terminated and an error alert tone sounds.

Storing Channels in Memory

From the Working Channel mode, select the channel to be stored. Press the FUNC key followed by the 1/MEM key. The MEM indicator appears when the registration is complete.

Deleting Channels from Memory

From the Working Channel mode, select the channel to be deleted. Press the FUNC key followed by the 1/MEM key. The MEM indicator disappears when the channel is deleted.

3.5.14 Setting the Transmission Power Output

The transmission output can be set at either 1W or 25W. When the power supply is switched on, the output is 25W. Pressing the FUNC key followed by the 9/1/25 key alternates the transmission between 25W and 1W.

When 1W is selected, the 1W indicator is displayed on the LCD. When 25W is selected the 1W indicator disappears.

3.5.15 Desensitized Reception (Local Mode)

You can set the RAY230/E to reduce the receiving sensitivity in high traffic areas to decrease unwanted reception. This is also known as local mode.

To start Sensitivity Reduction, press the FUNC key followed by the 7/D/L key. While the desensitize function (local mode) is active, the DESENS indicator appears in the LCD display. To return to full receiver sensitivity (distant mode), again press the FUNC 7/D/L key combination.

3.5.16 LCD Backlight Function

LCD backlight brightness can be set at four different levels. Press the FUNC/DIM key two times to enter Dimmer mode. Each successive click of the FUNC/DIM key alternates the brightness from Off, to Low, to Medium, to High, then back to Off. As the backlight setting is changed, the dot matrix indicator displays the following messages: DIM OFF for the Off setting, DIM LOW for Low, DIM MID for Medium, and DIM HI for High.

When the ENT or CLR keys are pressed or when no other key operation is made for 5 seconds, the current state is accepted and stored in memory, and the backlight setting operation is complete.

The next time the radio is powered on, the backlight state of the handset is recalled and applied. Separate backlight settings are retained for each handset.

When selecting the DIM OFF setting or pressing any key while in DIM OFF mode, the display is lit at the DIM LOW setting for 5 seconds and then turned off. This is so that you can view the display in low light conditions.

3.5.17 Hailer Mode

The Hailer operation enables the unit to use a Hailer Horn as a loudspeaker. To start the Hailer operation, press the FUNC key followed by the */HAIL key. During Hailer mode, **LdH** appears on the 7-segment display.

Press and hold PTT to place the unit in Hailer mode. The message HAILING appears in the dot matrix display. Anything spoken into the handset is amplified and broadcast from the Hailer Horn (but not transmitted over the radio). To adjust the Hailer Horn broadcast volume, use the VOL UP/DOWN keys while pressing and holding PTT. Each handset retains its own volume setting for the next time the unit is powered on.

Release PTT to switch to Listen mode. LISTEN appears in the dot matrix display and the Hailer Horn then acts as a directional microphone. Sounds picked up by the Hailer Horn can be heard on the handset speaker when off the cradle. Press the VOL UP/DOWN keys to adjust the handset speaker volume. Each handset has its own volume setting. When the handset is on the cradle, sounds picked up by the Hailer Horn can be heard on the External Speaker. Adjust the External Speaker volume by rotating the knob on the speaker itself.

To cancel the Hailer operation, again press FUNC followed by */HAIL or press the CLR key.

3.5.18 Fog Alert/Siren Mode

The Fog Alert / Siren operation enables the radio to emit various fog horn and siren alerts over a Hailer Horn speaker. To start the Fog Alert operation, press the FUNC key followed by the #/FOG key. During Fog Alert mode, **FOG** appears on the 7-segment display.

Use the SQ UP \wedge and SQ DOWN \vee keys to select one of the following modes, then press the ENT key to enable the selection:

- Manu. Fog** Pressing the PTT switch sounds a 500 Hz tone.
- Auto Fog** Every 115 seconds, the unit sounds a 500 Hz tone for 5 seconds duration.
- Siren** Pressing the PTT switch sounds one of 4 siren sounds that are set up in the Menu mode (see section 3.5.30.4.3).

The following table lists the four siren sounds and the procedure for emitting them from the Hailer Horn speaker.

CAUTION: The siren sounds available in this radio are for recreational purposes only. It is your responsibility to exercise caution and common prudence when emitting these siren sounds.

Number	Sound	How to Operate the Siren
1	"Hi-Lo"	Press and hold PTT switch to emit sound. Release PTT to stop.
2	Siren	Press and hold PTT switch to emit sound. Release PTT to stop.
3	Whelp	Press and hold PTT switch to emit sound. Release PTT to stop.
4	Air Horn	Press and hold PTT switch to emit sound. Release PTT to stop.

A message appears on the right side of the dot matrix display depending on the mode selected: MANU for Manual Fog, AUTO for Auto Fog, and SIREN for Siren sounds.

To activate the tone, press and hold the PTT switch. ACT is displayed on the left side of the display and the selected fog alert or siren is sounded from the Hailer Horn. To adjust the Hailer Horn broadcast volume, use the VOL UP/DOWN keys while pressing and holding PTT. Each handset has its own volume setting, which is retained the next time radio is powered on.

Release PTT to switch off the tone. LIS is displayed on the left side of the dot matrix display as the radio enters Listen mode. The Hailer Horn then acts as a directional microphone. Sounds picked up by the Hailer Horn are heard on the handset speaker when off the cradle. Press the VOL UP/DOWN keys to adjust the handset speaker volume. Each handset has its own volume setting. When the handset is on the cradle, sounds picked up by the Hailer Horn can be heard on the External Speaker. Adjust the External Speaker volume by rotating the knob on the speaker itself.

To cancel the Fog Alert operation, again press FUNC followed by #/FOG or press the CLR key.

3.5.19 DTMF Interface Operation (Optional)

A cellular fixed wireless terminal (such as the RAYCOM Fixed Cellular Wireless Terminal) or other radio communications device with a Dual Tone Multi-Frequency (DTMF) interface (such as some Inmarsat Mini-M's) can be connected to the RAY230 or RAY230E, using an optional interface to the AUX terminal.

One handset is used for DTMF phone operation while the other handset(s) monitor(s) transmissions on the last selected working or weather channel. The other handset(s) can only make a radio call by pressing and holding CLR for three seconds. This terminates the phone call and gives your handset priority over the handset making the phone call. Also, when any DSC call is received or a distress call is transmitted, phone operation is interrupted and radio operation is given priority. Channel 70 is always monitored for incoming DSC calls.

Making a call

To make a phone call, remove the handset from the cradle hook and press the FUNC key followed by the 3/CELL key. **CEL** appears on the 7-segment display. Enter the telephone number to be called with the numeric keypad. The number you just input appears on the dot matrix display. If the phone number exceed 9 digits, the number scrolls and only the last 9 digits are visible.

Press the ENT key to verify the number on the dot matrix display is correct. Then press ENT again to send the call. Make your phone call as usual. When the call is complete, hang the handset on the cradle hook or again press FUNC followed by 3/CELL. The unit returns to normal operation.

Receiving a call

When a phone call is received, an alert tone is sounded and INCOMING CELL CALL is indicated on the dot matrix display. To answer the call, press the FUNC key followed by the 3/CELL key. Any handset can be used to answer an incoming call but when the call is answered, only this handset can be used for cellular phone operation. Other handsets can only be used for radio signal receiving.

3.5.20 Intercom Mode

When more than one handset is installed, Intercom operation enables talking among the stations (handsets). To start Intercom mode, press the FUNC key followed by the 0/IC key. If only one handset is installed, the operation is cancelled and an error alert sounds.

Notes:

- *The station number can be changed to any name up to a length of 9 letters using the Menu operation. For the details, refer to Section 3.5.30 Menu Operation.*
- *Intercom operation is a duplex operation (much like the telephone in your house), so communication can be performed without pressing the PTT switch.*
- *Although any of the handsets can initiate an intercom call, only one handset can perform this function at a time.*

Making a Call

Press the FUNC key followed by the 0/IC key to enter Intercom mode. Use the SQ UP \wedge and SQ DOWN \vee keys to choose the station (handset) to be called: HANDSET 1, HANDSET 2 or HANDSET 3. Then press the ENT key to enter your selection. While calling, CALLING and the Handset being called appear on the dot matrix display. When the other station is on the line, the message CALLING turns to CONNECT. If the other station does not respond within one minute, the unit exits Intercom mode.

To exit Intercom mode, hang the handset on the cradle, press the CLR key, or again press FUNC followed by 0/IC.

Receiving a Call When the Handset is on the Cradle

When an Intercom call is received, the external speaker emits a calling tone and CALL FROM with the name of the calling station appear on the dot matrix display once every second. To answer the call, press the FUNC key followed by the 0/IC key. The calling tone ceases and the message CONNECT appears in the dot matrix display.

Note: *If the handset is not taken out of the cradle within 1 minute after being called, the call terminates and the dot matrix display returns to its previous state.*

To exit Intercom mode, hang the handset on the cradle, press the CLR key, or again press FUNC followed by 0/IC.

Receiving a Call When the Handset is Off the Cradle

When an Intercom call is received, the handset speaker emits a calling tone and CALL FROM with the name of the calling station appear on the dot matrix display once every second. To answer the call, press the FUNC key followed by the 0/IC key. The calling tone ceases and the message CONNECT appears in the dot matrix display.

Note: *If the call is not answered within 1 minute, the call is terminated and the dot matrix display is returned to its previous state.*

To exit Intercom mode, hang the handset on the cradle, press the CLR key, or again press FUNC followed by 0/IC.

3.5.21 Scan Mode

During Scan mode, the RAY230/RAY230E searches through the channels, stops when radio traffic is detected, then resumes scanning after the traffic ceases. Two scan functions are available: All Channel Scan and Memory Channel Scan. The All Channel Scan function searches all channels (except Weather Channels, Private Channels, or Channel 70) within the same frequency group. The Memory Channel Scan searches only the channels stored in memory in the same group.

The scan begins from the channel following the one currently indicated and is suspended when a carrier is detected. Five seconds after the carrier ceases, the scan resumes with the next channel. If the carrier is detected again before 5 seconds elapse, the timer is re-initialized. Press the 2/SCAN key to resume the scan from the next channel. Press and hold 2/SCAN for 3 seconds to cancel the scan.

Upon reaching Channel 88, the radio scrolls back to Channel 1 and continues the scan. If the scan stops on a channel with traffic and you wish to communicate with the other party, press the PTT switch to cancel the scan and remain on that channel.

Note: *Both Scan functions exclude Channel 70, which is used exclusively for receiving and transmitting Digital Selective Calling (DSC) functions.*

Using Memory Scan

This function is available only when at least one channel has been stored in memory. Press the FUNC key followed by the 2/SCAN key. The messages MEM and SCAN flash for 3 seconds on the LCD. A scan of only the channels in memory is initiated when the 3 seconds elapse or when you press the ENT key before the 3 seconds elapse.

Pressing the 2/SCAN key or the CLR key during the scan cancels Memory Scan.

Note: *No key functions are accepted while transmitting, Multi-calling, or operating on the Weather or Private channels.*

Using All Scan

Press the FUNC key followed by the 2/SCAN key. The messages MEM and SCAN flash for 3 seconds on the LCD. Before the 3 seconds elapse, press the 2/SCAN key again to begin All Scan. If the 3 seconds elapse before you press the 2/SCAN key, the radio will enter Memory Scan.

Pressing the 2/SCAN key or the CLR key during the scan cancels All Scan.

Note: *No key functions are accepted while transmitting, Multi-calling, or operating on the Weather or Private channels.*

3.5.22 Monitor Mode

Monitor operation can be implemented in one of two modes: Dual-Watch or Tri-Watch.

Dual-Watch

In Dual-Watch Mode, the RAY230/RAY230E operates on the Working Channel while constantly monitoring the Priority Channel. The radio locks onto the Priority Channel or the Working Channel whenever it becomes active, then returns to Dual-Watch when there is no activity.

To start Dual-Watch Mode, select the desired Working Channel then press the MON key. The Working Channel is displayed on the 7-segment display and the Priority Channel appears on the right side of the dot matrix display.

To end Dual-Watch mode at the current channel, press the MON key or the CLR key. If Dual-Watch mode is initiated at Channel 70, the operation is cancelled and an error alert sounds.

Tri-Watch for US Model RAY230

In Tri-Watch Mode, the RAY230 operates on the Working Channel while constantly monitoring the Priority Channel then the previously selected Weather Channel for severe weather alert broadcasts. When a signal is detected on the Working Channel or Priority Channel, that channel becomes active. When there is no longer any activity on the Working Channel or Priority Channel, the RAY230 returns to Tri-Watch.

If a weather alert broadcast is detected, the RAY230 emits an alert tone and the WX indicator blinks. Tri-Watch mode terminates and the radio switches to the WX channel to monitor the severe weather broadcast.

To start Tri-Watch mode, select the Working Channel then press the FUNC key followed by the MON/TRI key. The Working Channel appears on the 7-segment display, the Priority Channel appears on the right-most portion of the dot matrix display, and the Weather Channel appears on the left-most portion of the dot matrix display.

To end Tri-Watch mode at the current channel, press the MON key or the CLR key. If Tri-Watch mode is initiated at Channel 70, the operation is cancelled and an error alert tone sounds.

Tri-Watch for European Model RAY230E

In Tri-Watch Mode, the RAY230E operates on the Working Channel while constantly monitoring Channel 16. Then, a third user-selectable channel is monitored: either the previously selected Weather Channel (in US mode) or the last used Multi-Call Channel (in International mode). When a signal is detected on one of the other channels, that channel becomes active. When there is no longer any activity on the active channel, the RAY230E returns to Tri-Watch.

To start Tri-Watch mode, select the Working Channel then press the FUNC key followed by the MON/TRI key. The Working Channel appears on the 7-segment display, Channel 16 appears on the right-most portion of the dot matrix display, and the Weather Channel or Multi-Call Channel appears on the left-most portion of the dot matrix display.

To end Tri-Watch mode at the current channel, press the MON key, the CLR key, or the PTT switch. If Tri-Watch mode is initiated at Channel 70, the operation is cancelled and an error alert tone sounds.

3.5.23 Priority Using Multiple Handsets

If more than one handset has been installed, the station with the highest priority has control of the radio's operation when it is taken off the cradle hook. A handset's priority ranking is determined by its station number, with Handset One having the highest rank and Handset Three having the lowest. Handset One should be located where the ship is normally navigated from (such as the wheel house), so in the event of an emergency, this handset can take immediate control of the transceiver. The handset name as shown in the dot matrix display can be changed to any name up to a length of 9 letters using the Menu operation described in section 3.5.30.4.1 Intercom Set Up.

Note: Normally, when Handset 1 is removed from the cradle, it automatically takes priority from either of the other two Handsets. In some instances, though, it may be necessary to press and hold the CLR key for 3 seconds before Handset 1 regains priority.

Operation States

Since it has highest priority, key operation is always possible from Handset 1 even while On-Hook. Operation of the other two handsets depends on their On/Off-Hook status.

In these examples, disabled operation means a handset can only be used to make a Distress Call. Limited operation means a handset can be used to talk on the Intercom, adjust the sound volume, and make a Distress Call.

1. All Handsets On-Hook



2. All Higher-ranked Handsets On-Hook



3. Higher-ranked Handset is taken Off-Hook while a lower-ranked Handset is Off-Hook



4. Handset 1 is Off-Hook while other stations are On-Hook



5. Handset 1 is Off-Hook while another Handset is Off-Hook



6. All Handsets are Off-Hook



Handset Display

The dot matrix display indicates the handset's rank. If Handset 1 has priority, for example, the message AVAILABLE is displayed on the LCD of Handset 1 while HANDSET 1 (or the currently assigned handset name) is displayed on the LCD of the other handsets.

1. If all Handsets are On-Hook



2. If only Handset 1 is Off-Hook

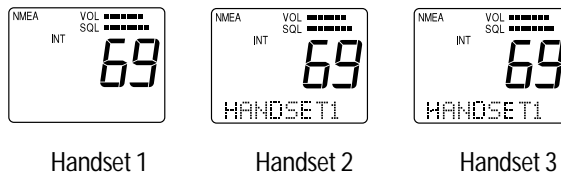

3. If only Handset 2 is Off-Hook.



3.5.24 NMEA Operation

The RAY230/RAY230E can receive valid position and time information, which are transmitted during a DSC Distress call. This data can be communicated via SeaTalk or NMEA 0183 from a GPS, fishfinder, radar, or any device that outputs or repeats GPS sentences. If the radio does not detect the positional data, it provides different alerts urging you to find and correct the fault or manually input the data using the radio's L/L ENT function, as described in section 3.5.30.3.2. Current valid positional data, whether from external device or manually input, can be viewed using the NAVSTAT Operation described in section 3.5.30.2.

If a GPS device is not connected via SeaTalk or NMEA, the radio emits a 5-second-long staccato alert tone and flashes the NMEA indicator 2 minutes after power up. This occurs every time the unit is turned on. The alarm is required by safety regulations and cannot be disabled.

Operation at Power Up

At power up, the SeaTalk line is monitored for 1 minute. If a signal is detected, the radio determines whether the data is valid. If valid, the data is input, the NMEA indicator is displayed on the LCD of all handsets, and the radio enters normal operation mode. The radio assumes all future data is to be received on SeaTalk, so will not again monitor the NMEA line (until the next time the handset goes through the power up sequence).

If no signal is detected on SeaTalk, the radio next monitors the NMEA line for 1 minute. If a signal is detected on NMEA, the radio determines whether the data is valid. If valid, the data is input, the NMEA indicator is displayed on handsets, and the radio enters normal operation mode. The radio assumes future data is to be received on NMEA, so will not again monitor the SeaTalk line (until the next time the handset goes through the power up sequence).

If no GPS signal is detected on either SeaTalk or NMEA after the 2 minute polling period, a 5-second-long staccato alert tone is emitted and the NMEA indicator flashes. All the position fields are set to 9's and the time and date fields are set to 8's. The message NO GPS appears in the NAVSTAT screen, although no positional data is displayed.

If at a later time valid data is received on NMEA, the data is input, the NMEA indicator is displayed solid (no longer flashing), and the radio enters normal operation mode. However, because the radio does not poll for SeaTalk data after finding none within the first minute of powering on, SeaTalk data would not be detected, even if valid, until the next time the handset goes through the power up sequence.

Note: *If SeaTalk positional data is not input within the first minute of power up, you must cycle the handset OFF and ON again before a restored signal can be detected.*

Operation When the Signal is Lost or Becomes Invalid

If positional data that was previously detected becomes invalid or is no longer detected, the radio polls the last detected line (SeaTalk or NMEA) for 1 minute for it to be restored. The radio will not search for a signal on SeaTalk if the signal was last seen on NMEA, or vice-versa.

Note: *Because the radio only polls for the last detected input (SeaTalk or NMEA) when a signal is lost, you must cycle the handset OFF and ON again to properly detect positional data if the source is switched from SeaTalk to NMEA or vice-versa.*

If a signal is restored on the last detected line (SeaTalk or NMEA) and the radio determines the data is valid, the data is input, the NMEA indicator remains illuminated, and the radio re-enters normal operation mode.

However, if no signal is detected, the NMEA indicator flashes and a 5-second-long staccato alert tone is emitted. The last received positional data is retained in memory and can be viewed in the NAVSTAT screen. The message NO GPS appears in NAVSTAT in the position where the type of device used to be. The NMEA indicator continues to flash until valid positional data is received. If valid positional data (from the same source) is later restored, the NMEA indicator is again displayed solid.

Operation When No Signal Detected for 4 Hours

If no valid positional data is received or input manually within 4 hours of the previous alert, the NMEA indicator continues to flash and the staccato alert tone is again emitted. This pattern is repeated every 4 hours if no positional data has been detected. If no manual input was made during the previous 23.5 hours, all the position fields are set to 9's and the time and date fields are set to 8's.

3.5.25 SeaTalk Operation

The RAY230/RAY230E can receive SeaTalk position and time information from any SeaTalk capable device. As with NMEA data, if the position information becomes invalid or is not present, you will be prompted to manually input position data.

3.5.26 Digital Selective Calling (DSC)

The Digital Selective Calling (DSC) protocol is a globally applied system used to send and receive digital Distress calls as well as Individual and All-Ships calls on channel 70, the dedicated DSC channel for Marine VHF. DSC operation includes the following:

1. Transmitting/Receiving an Individual Call
2. Transmitting/Receiving a Group Call
3. Transmitting/Receiving an All Ships Call
4. Transmitting/Receiving a Distress Call
5. Receiving a Distress Relay Call

Actually, the RAY230/E has a separate receiver exclusively for Channel 70 so that even if receiving under normal operation, the unit can quickly switch over to Channel 70 upon receiving a DSC signal. When the DSC signal is received, the unit performs the corresponding operation. If the radio is transmitting, however, receiving on Channel 70 is disabled.

Note: An MMSI number is required to operate the Digital Selective Calling (DSC) equipment in this radio. You can program the MMSI number yourself one time only using the Menu Operation described in section 3.5.30.4.2. Otherwise, your Raymarine dealer can program or change the number for you.

3.5.26.1 Individual Call to Another Ship (Ship-to-Ship)

An Individual Ship's Call is a DSC call made to a specific ship identified by its MMSI number. There are three types: ROUTINE for normal calls, SAFETY for advisory alerts, and URGENCY for assistance when life is not in immediate danger.

The RAY230/230E can receive all three types of Individual calls but can only transmit ROUTINE Individual calls. As with any DSC operation, the call is made on channel 70.

Transmitting an Individual Call

To call another ship, you must select the Working Channel and a specific MMSI number. The MMSI number is selected either manually or from a Phonebook list of preprogrammed numbers specified using the MENU function described in section 3.5.30.3.3. To cancel the call, press and hold the CLR key for 3 seconds.

Press the INDV key to initiate the call data setup operation. After setting the call data, press the PTT switch to send the call. The following describes the two types of calling operations: Individual Ship's (ship-to-ship) Call and Shore station (ship-to-shore) Call.

To Make an Individual Call to Ship (ship-to-ship):

1. Press the INDV key. **Ind** appears on the 7-segment display and the DSC indicator is displayed. Pressing the SQ UP/DOWN key alternates between SHIP and SHORE.

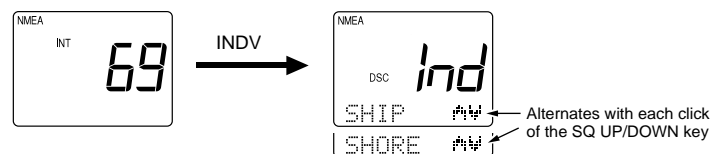

2. Select SHIP and press the ENT key.
3. Scroll with the SQ UP/DOWN keys to select the method for inputting the MMSI number, either from the Phonebook or manually. Press ENT.

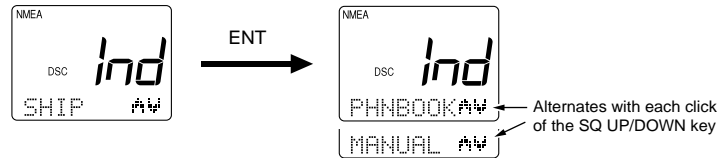

4. Select the MMSI number.

BY PHONEBOOK:

Scroll with the SQ UP/DOWN keys, select the name associated with the desired MMSI number, and press the ENT key. If the MMSI number is not listed in phonebook, the display reverts to manual input.

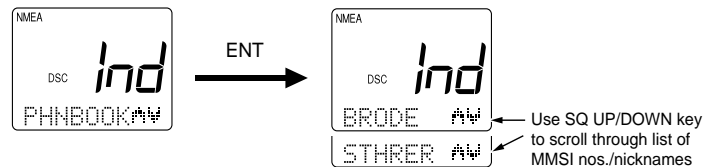

OR

BY MANUAL INPUT:

Input the 9-digit MMSI number with the numeric keypad, then press the ENT key.

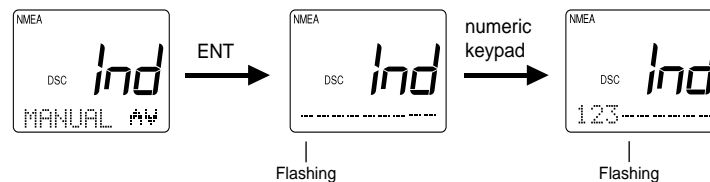

5. Specify the Working Channel with the SQ UP/DOWN keys and press the ENT key.

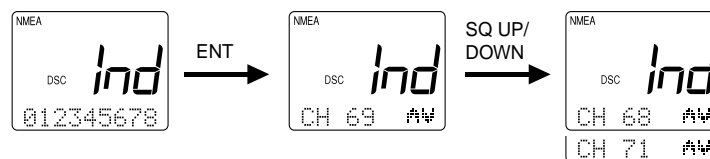

6. Press the ENT key again. A prompt appears on the display instructing you to press the PTT switch.
7. Press PTT to transmit.

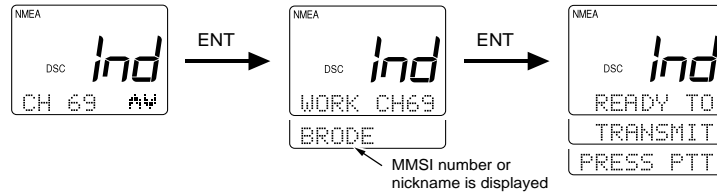

Note: Only simplex channels (those channels that transmit and receive on the same frequency) can be selected for ship to ship Individual Calls. Pressing the SQ UP/DOWN will scroll you through the simplex channels usable for this operation.

Response

If a response is received after pressing the PTT switch, a receive-confirmation message is displayed. After 5 seconds have elapsed, the channel is changed to a communication channel and the Individual Ships Call is completed.

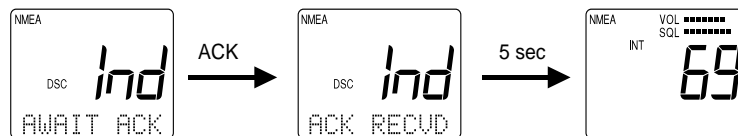

If no response is received for 3 minutes after pressing the PTT switch, a prompt to press the PTT switch appears once more. After 15 seconds elapses without pressing the PTT switch following the prompt, operation returns to the state before the call.

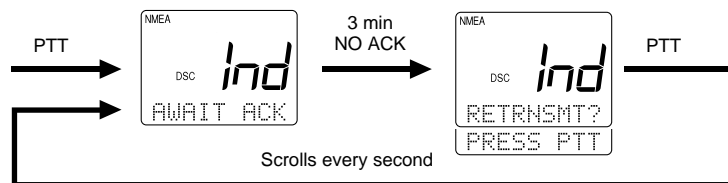

3.5.26.2 Individual Call to Shore Station (Ship-to-Shore)

To call a shore station, you must select the specific MMSI number. The MMSI number can be entered manually or selected from a Phonebook list of preprogrammed numbers specified using the MENU function described in section 3.5.30.3.3. Channel 16 is automatically assigned for communications. To cancel the call, press and hold the CLR key for 3 seconds.

To make an Individual Call to Shore Station (ship-to-shore):

1. Select the Shore Station channel.
2. Press the INDV key. **Ind** appears on the 7-segment display and the DSC indicator is displayed. Pressing the SQ UP/DOWN key alternates between SHIP and SHORE.

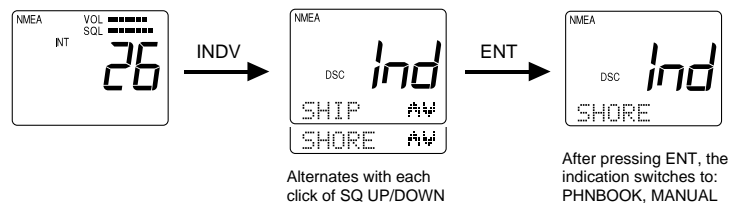

3. Select SHORE and press the ENT key.
4. Scroll with the SQ UP/DOWN keys to select the method for inputting the MMSI number, either from the phonebook or manually. Press ENT to input your selection.
5. Select the name by MMSI number from the phonebook by scrolling with the SQ UP/DOWN keys, and pressing the ENT key.

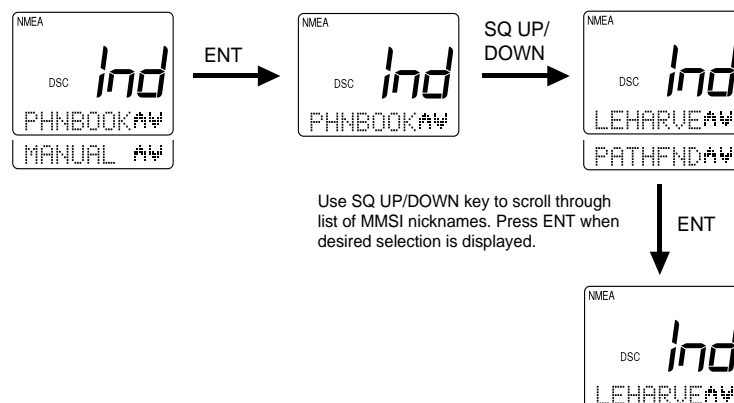

OR

Manually input the MMSI number with the numeric keypad, then press the ENT key.

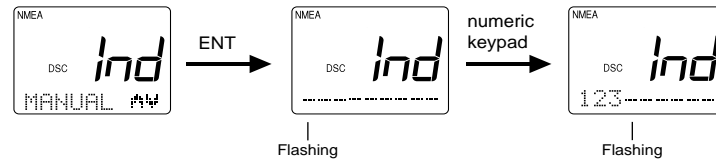

6. Press ENT again. A prompt appears on the display instructing you to press the PTT switch.

7. Press PTT to transmit.

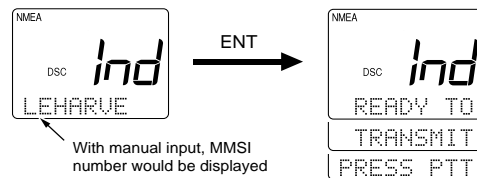

Response

If a response is received after pressing the PTT switch, a receive-confirmation message is displayed. After 5 seconds have elapsed, the channel is switched to a communication channel and the Individual Call is completed.

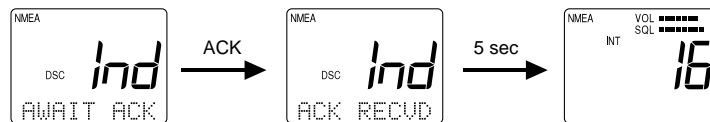

If no response is received for 3 minutes after pressing the PTT switch, a prompt to press PTT appears once more. If the PTT switch is not pressed within 15 seconds after the prompt appears, operation returns to the state before the call.

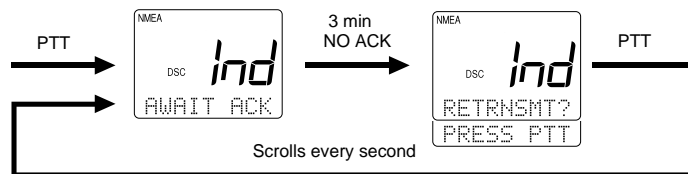

3.5.26.3 Receiving an Individual Call

When an Individual Call is received, the DSC indicator flashes, **Ind** appears on the 7-segment display, and the DSC Received Alert is sounded. On the dot matrix display appears the message RECEIVED IND CALL along with the type of call. There are three types of Individual calls: ROUTINE for normal calls, SAFETY for advisory alerts, and URGENCY for assistance when life is not in immediate danger. If the MMSI number exists in the Phonebook list, the associated name is also displayed. If no match is found, the actual numeric value of the MMSI is displayed. Lastly appears a prompt to press ENT to accept or CLR to log the call. This sequence scrolls every second.

Until either the ENT key or the CLR key are pressed, the prompt is flashed at 1-second intervals and is accompanied by an alarm for up to 3 minutes. If neither ENT nor CLR are pressed during these 3 minutes, the radio reverts to the operation mode before receiving the Individual Call. The DSC indicator continues to be flashed on the LCD display until the contents of the log files can be confirmed.

If ENT is pressed, the alarm is turned off, and a new prompt appears on the display, instructing you to press the PTT switch. Press PTT to transmit an acknowledgment (ACK). If PTT is not pressed within 5 seconds of the prompt appearing, the transmission is done automatically. Pressing PTT switches the radio to the communication channel.

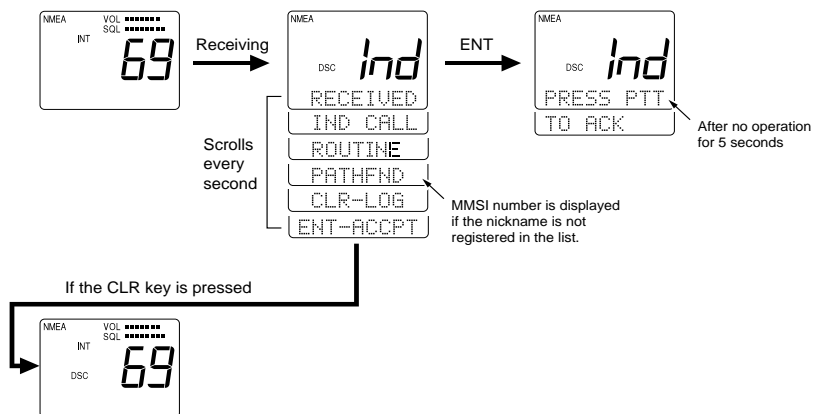

If the CLR key is pressed, the alarm is turned off, the displays are cleared, and the received contents are stored in the Log File. The radio then reverts to the operation mode before receiving the Individual Call.

3.5.26.4 Transmitting a Group Call

You can send and receive DSC calls from groups of stations that share the same MMSI number. There are three types: ROUTINE for normal calls, SAFETY for advisory alerts, and URGENCY for assistance when life is not in immediate danger.

The RAY230/230E can receive all three types of Group calls but can only transmit ROUTINE Group calls. As with any DSC operation, the call is made on channel 70.

To make a Group Call:

1. Set up the Group MMSI number as outlined in Section 3.5.30.3.4.
2. Press the INDV key. **Ind** appears on the 7-segment display, the DSC indicator is illuminated, and SHIP appears on the dot matrix display.
3. Press the SQ UP/DOWN key to alternate between SHIP, SHORE, and GROUP. Stop on GROUP. The GROUP message only appears if you have set up the Group MMSI number as outlined in Section 3.5.30.3.4.
4. When GROUP appears, press the ENT key. **GrP** appears on the 7-segment display and the registered Group MMSI number appears on the dot matrix display.

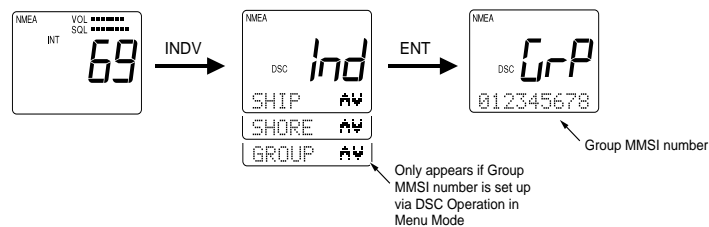

Note: Since only one group MMSI number can be registered at a time, only one MMSI number can be displayed when GROUP is selected. To change the group MMSI number, see Section 3.5.30.3.4.

5. Press ENT to accept the MMSI number.
6. Use the SQ UP/DOWN key to select the Working Channel for communication.
7. When the desired channel number appears, press ENT. The dot matrix display scrolls between the Working Channel and the Group MMSI number.

8. If this information is correct, press ENT to accept. A new message appears, prompting you to press the PTT switch.
9. Press PTT. The radio changes over to the selected Working Channel without waiting for acknowledgment.

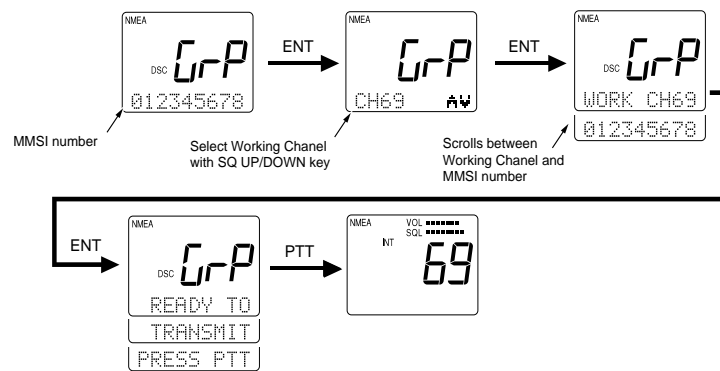

3.5.26.5 Receiving a Group Call

When a Group Call is received, the DSC indicator flashes, **Grp** appears on the 7-segment display, and the DSC Received Alert is sounded. On the dot matrix display appears the message RECEIVED GRP CALL, along with the type of call: ROUTINE, SAFETY, or URGENCY. If the MMSI number exists in the list, the associated name is displayed. If no match is found, the actual numeric value of the MMSI is displayed. You are then prompted to press ENT to accept or CLR to log the call.

Until either the ENT key or the CLR key are pressed, the prompt is flashed at 1-second intervals and is accompanied by an alarm for up to 3 minutes. If neither ENT nor CLR are pressed during these 3 minutes, the radio reverts to the operation mode before receiving the Group Call. The DSC indicator continues to be flashed on the LCD display until the contents of the log files can be confirmed.

If ENT is pressed, the alarm is turned off, and a new prompt appears on the display, instructing you to press the PTT switch. Press PTT to transmit. If PTT is not pressed within 5 seconds of the prompt appearing, the transmission is done automatically. Pressing the PTT switch causes the channel to change to the communication channel.

If the CLR key is pressed, the alarm is turned off, the displays are cleared, and the received contents are stored in the Log File. The radio then reverts to the operation mode before receiving the Group Call.

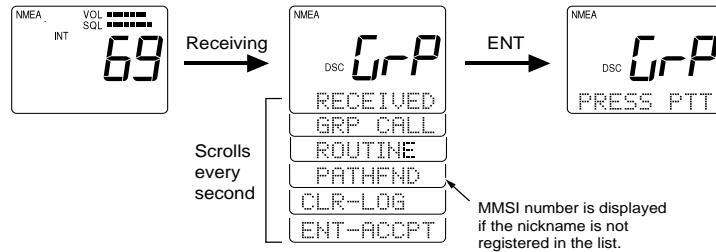

3.5.26.6 Transmitting an All Ships Call

The All Ships Call is used to send out a message to all ships in range that you need assistance but the situation is not serious enough for a Distress Call. This call should only be used if hailing for assistance on channel 16 fails. There are three types of All Ships Calls: ROUTINE for normal calls, SAFETY for advisory alerts, and URGENCY for assistance when life is not in immediate danger. The RAY230/230E can receive all three types of these calls but call only transmit SAFETY and URGENCY. As with any DSC operation, the call is made on channel 70. Then, after the All Ships Call is sent or received, the radio automatically selects channel 16.

To send an All Ships Call

1. Press the ALL SHIP key. The message SAFETY appears on the dot matrix display and the DSC indicator illuminates.
2. Press the SQ UP/DOWN key. The message URGENCY now appears on the dot matrix display.
3. Make your selection between SAFETY or URGENCY and press the ENT key to submit. The prompt RECONFIRM is displayed.
4. Press the ENT key to confirm. A prompt appears on the display, instructing you to press the PTT switch.
5. Press PTT to transmit the call.

The All Ships Call is made on Channel 70. After the All Ships Call is sent, the radio automatically switches to channel 16.

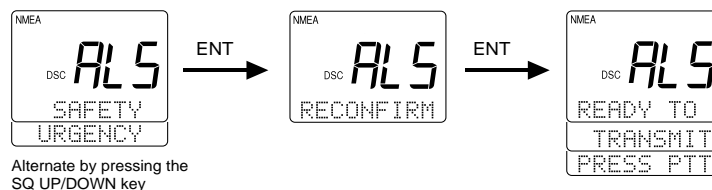

3.5.26.7 Receiving an All Ships Call

When receiving an All Ships Call, the unit's manner of response depends on the type of call received.

When an URGENCY call is received, the DSC Distress alert is sounded. The LCD displays a message that an URGENCY call is being received, along with the sender's MMSI number, and a prompt to press ENT to accept or CLR to log the call. The DSC Distress alert and the displayed message continue until either ENT or CLR is pressed. If ENT is pressed, the radio switches to Channel 16 and the contents of the communication are stored in memory. If CLR is pressed, the radio reverts to the mode before receiving the URGENCY Call and the contents are stored in memory.

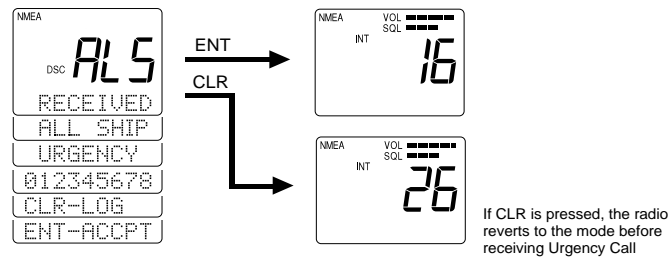

When a SAFETY call is received, the DSC Received alert is sounded. The LCD displays a message that an SAFETY call is being received, along with the sender's MMSI number, and a prompt to press ENT to accept or CLR to log the call. The DSC Received alert and the displayed message continue until either ENT or CLR is pressed. If ENT is pressed, the radio switches to Channel 16 in mode and the contents of the communication are stored in the log. If CLR is pressed, the radio reverts to the mode before receiving the SAFETY Call and the contents are stored in the log.

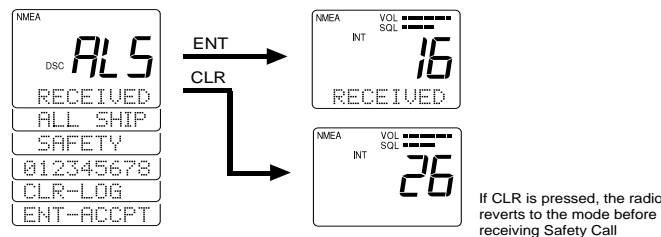

3.5.26.8 Transmitting a Distress Call

Two types of Distress Calls can be made: one that specifies the type of distress and one that does not.

Unspecified Distress Call

To make a Distress Call without specifying type of distress:

1. Open the door labeled DISTRESS on the back of the handset and press and hold the DISTRESS button. After one second, **dSr** flashes on the 7-segment display and the DSC indicator appears. On the dot matrix display, countdown message appears prompting you to hold the DISTRESS key for 4 more seconds.
2. Continue to hold the DISTRESS button for the duration of the countdown. An alert tone is sounded at one-second intervals.

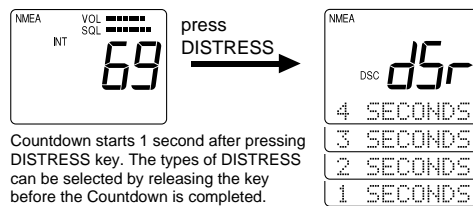

Note: If you fail to hold the button for the full 4 seconds, the DISTRESS call will be cancelled.

3. After the countdown has completed, the message RELEASE appears on the dot matrix display. Release the DISTRESS button.

The unit switches to channel 16, displays the message AWAIT ACK, and monitors channel 70 for an acknowledgment.



The unit retransmits the DISTRESS call at random intervals of 3.5 to 4.5 minutes, until a response is received or the call is manually cancelled.

To cancel the DISTRESS call, press the CLR key and hold for 3 seconds. The call is cancelled and the unit returns to the state before the call.

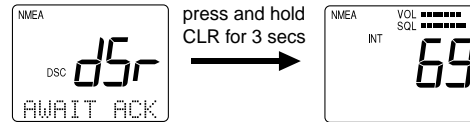

When a response is received, the DSC indicator flashes and the DSC Distress alert is sounded. The LCD scrolls a message that the DISTRESS has been acknowledged, along with the sending station's MMSI number or nickname. The message and alert are repeated until the CLR key is pressed.

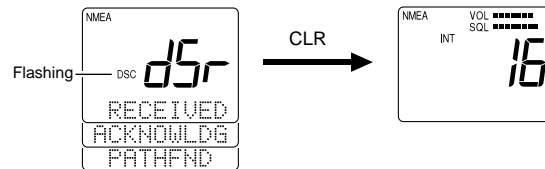

When the CLR key is pressed, the unit exits the DSC mode continues monitoring Channel 16 on high power.

Regardless of the handset state, the DSC Distress alert is sounded at maximum volume on the external speaker, even if the volume knob has been rotated all the way OFF.

You can mute the alert tone by pressing the CLR key for one second. Pressing CLR only turns off the alert sound; it does not interrupt the Distress call.

Specified Distress Call

You can assign one of eleven distress types to the call to provide the potential rescuing station additional information if time and circumstances permit. The Nature of the distress call can be selected using the DISTRESS key as outlined below or in the system MENU as outlined in Section 3.5.30.3.1. Below are the messages and their meanings:

Message	Meaning	Message	Meaning
FIRE	fire	ADRIFT	drifting
FLOODNG	flooding	UNDESIG	undesignated
COLLISN	collision	ABNDSHP	abandoning ship
AGROUND	run aground	PIRACY	piracy
LISTING	listing	MANONBD	man overboard
SINKING	sinking		

To make a Distress Call specifying the type of distress:

1. Open the door labeled DISTRESS on the back of the handset and press and release the DISTRESS key on the back of the handset. **dSr** appears on the 7-segment display and the DSC indicator illuminates. On the dot matrix display, the message FIRE appears.

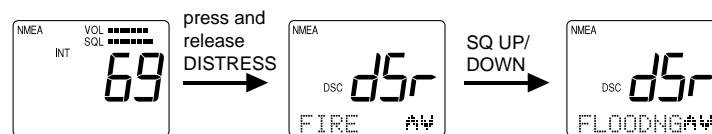

2. If FIRE is the message you wish to attach, press the ENT key.

OR

If FIRE is not the message you wish to attach, scroll through the list with the SQ UP/DOWN keys. When the appropriate message is displayed, press the ENT key.

On the dot matrix display, appears the distress type plus a message prompting you to press and hold the DISTRESS key.

3. To send the distress signal, press and hold the DISTRESS key. After one second, **dSr** flashes and a countdown message appears on the dot matrix display, prompting you to hold the DISTRESS key for 4 more seconds.
4. Continue to hold the DISTRESS key for the duration of the countdown. A tone sounds every second.

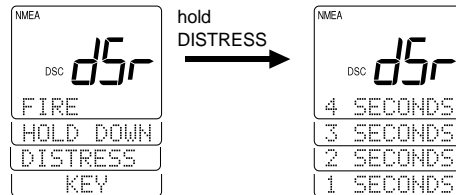

Note: If you fail to hold the button for the full 5 seconds, the DISTRESS call will be cancelled.

After the 5 seconds have elapsed, the message RELEASE appears, prompting you to release the key.

- When this prompt appears, release the DISTRESS key. The unit is switched to Channel 16, displays the message AWAIT ACK, and monitors channel 70 for an acknowledgment.

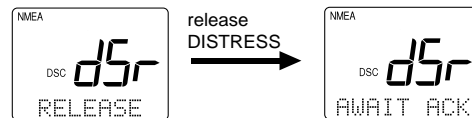

dSr stops flashing and the distress alarm sounds continuously. **You can mute the alert tone by pressing the CLR key for one second. Pressing CLR only turns off the alert sound; it does not interrupt the Distress call.**

The unit retransmits the DISTRESS call at random intervals of 3.5 to 4.5 minutes, until a response is received or the call is manually cancelled.

To cancel the DISTRESS call, press the CLR key and hold for 3 seconds. The call is cancelled and the unit returns to the state before the call.

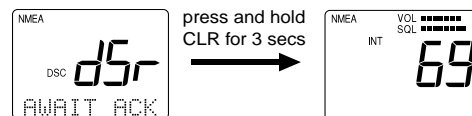

When a response is received, the DSC indicator flashes and the DSC Distress alert is sounded. The LCD scrolls a message that the DISTRESS has been acknowledged, along with the sending station's MMSI number. The message and alert are repeated until the CLR key is pressed.

When the CLR key is pressed, the unit exits the DSC mode continues monitoring Channel 16 on high power. Regardless of the handset state, the DSC Distress alert is sounded at maximum volume on the external speaker.

3.5.26.9 Receiving a Distress Call

When a Distress call is received, the DSC indicator flashes, **dSr** appears on the 7-segment display, and the DSC Distress alert is sounded. On the dot matrix display are scrolled RECEIVED, DISTRESS, the type of distress, the MMSI number, the transmitting time, the latitude, and longitude of the transmitting station.

The DSC Distress Alert and the displayed message continue until either ENT or CLR are pressed. Pressing ENT stores the contents of the call in the log and switches the radio to Channel 16. Pressing CLR also logs the call but then reverts the radio to the mode before receiving the Distress call.

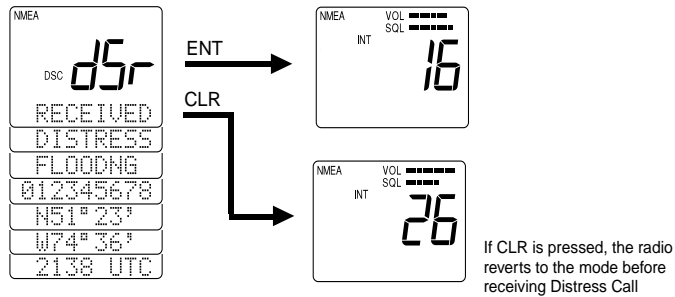

3.5.26.10 Receiving a Distress Relay Call

Sometimes a ship's distress call can be relayed from another ship or a shore station. The RAY230 can only receive a Relayed Distress call that has been addressed to All Ships.

When a Relayed Distress call is received, the DSC indicator flashes, **dSr** appears on the 7-segment display, and the DSC Distress alert is sounded. On the dot matrix display are scrolled RECEIVED, RELAY, the MMSI number of the station making the call, DISTRESS, the type of distress, the MMSI number of the ship in distress, the latitude and longitude of that ship, and the time of transmission.

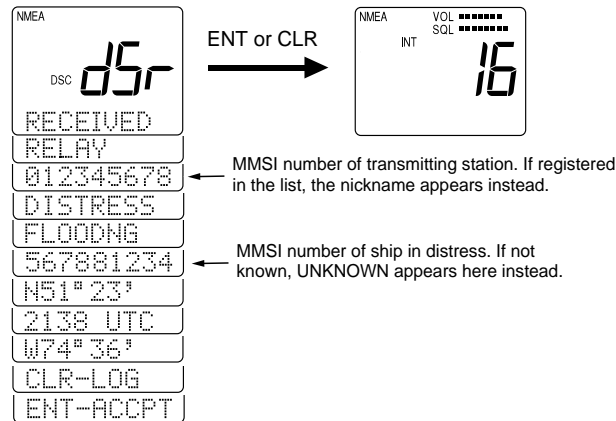

The displayed message continues until either ENT or CLR is pressed. At that time, the radio switches to Channel 16 in high power and the contents of the communication are stored in the Log File.

3.5.27 ATIS Operation (RAY230E only)

The RAY230E comes equipped with Automatic Transmission Identification System (ATIS) capability for inland waterway requirements in Europe. With ATIS enabled, each time the PTT switch is pressed your station ID is sent at the end of the transmission. Before utilizing this feature, you must obtain an ID number, program it into the RAY230E's system Menu, and activate the ATIS feature. Once activated, ATIS can be enabled or disabled in the system Menu so that the RAY230E can be used in open water or inland waterways.

3.5.28 Alert Operation

This function emits various sounds to attract the operator's attention for confirming a key operation, warning of an erroneous key operation, or informing of a specific state. The different types of alert sounds are described below.

1. Key Click

This sound is made when a handset key is pressed. In the On-Hook state the sound emits from the external speaker; in the Off-Hook state the sound emits from the handset speaker. The key click volume level is determined by the sound volume setting.

2. Operation Error Alert

This alert sounds when an erroneous key is pressed. In the On-Hook state the sound emits from the external speaker; in the Off-Hook state the sound emits from the handset speaker. The alert tone volume level is determined by the sound volume setting.

3. DSC Distress Alert

This sound is made when receiving a distress call in the DSC receiving mode, receiving an acknowledgment to a transmitted distress signal, or an Urgency signal to All Ships. The alert is output from the external speaker at the maximum sound volume, regardless of the handset volume setting.

4. DSC Received Alert

This sound is made when receiving an Individual Ships Call in DSC receiving mode, a Group Ships Call, or a Safety call to All Ships. In this case the sound is made from the external speaker. The alert is sounded at maximum volume regardless of the volume setting.

5. DSC Transmission Alert

This sound is emitted from the external speaker to notify that the DSC code is being sent after transmission is completed. The alert is sounded at maximum volume regardless of the volume setting.

6. Weather Alert

This sound is made at the detection of a NOAA Weather Alert. The alert is sounded from the external speaker at maximum volume regardless of the volume setting or handset state.

7. DTMF Phone Call Sound

This sound is emitted from the external speaker when a phone call is received by the optional DTMF interface, if installed. The call volume level is determined by the sound volume setting.

8. Intercom Call Sound 1

This sound is made upon receiving a call using the Intercom function, when selected through the Menu operation. If Off-Hook, the sound emits from the handset; if On-Hook, the sound emits from the external speaker at a low volume. The call volume level is determined by the sound volume setting.

9. Intercom Call Sound 2

This sound is made upon receiving a call using the Intercom function, when selected through the Menu operation. If Off-Hook, the sound emits from the handset; if On-Hook, the sound emits from the external speaker at a low volume. The call volume level is determined by the sound volume setting.

10. Intercom Call Sound 3

This sound is made upon receiving a call using the Intercom function, when selected through the Menu operation. If Off-Hook, the sound emits from the handset; if On-Hook, the sound emits from the external speaker at a low volume. The call volume level is determined by the sound volume setting.

11. Intercom Call Sound 4

This sound is made upon receiving a call using the Intercom function, when selected through the Menu operation. If Off-Hook, the sound emits from the handset; if On-Hook, the sound emits from the external speaker at a low volume. The call volume level is determined by the sound volume setting.

12. Siren 1 ("Hi-Lo" Sound)

Select this sound option under Siren in the Menu operation. While in Fog/Siren mode, pressing and holding the PTT switch emits a continuous "Hi-Lo" sound from the Hailer Horn speaker at the selected volume. Releasing PTT, the Hi-Lo sound stops.

13. Siren 2 (Siren Sound)

Select this sound option under Siren in the Menu operation. While in Fog/Siren mode, pressing and holding the PTT switch emits a continuous siren sound from the Hailer Horn speaker at the selected volume. Releasing PTT, the siren sound stops.

14. Siren 3 (Whelp Sound)

Select this sound option under Fog Siren 1 in the Menu operation. While in Fog/Siren mode, pressing and holding the PTT switch emits a whooping or "whelp" sound from the Hailer Horn speaker at the selected volume. When PTT is released, the whooping sound stops.

15. Siren 4 (Air Horn)

Select this sound option under Fog Siren 1 in the Menu operation. While in Fog/Siren mode, pressing and holding the PTT switch emits an air horn sound from the Hailer Horn speaker at the selected volume. When PTT is released, the air horn stops.

3.5.30 Menu Operation

The menu operation is used for making various settings and confirming the current state. The operation is roughly divided in three functions as follows:

Function	Purpose
1. NAVSTA	Indicates the information input from NMEA or SeaTalk.
2. DSC	To enter/modify various settings related to DSC.
3. SETTING	To register the names of stations for Intercom mode, to set the tone of the Fog Siren, to program the MMSI number, to program the ATIS ID number (RAY230E only) and to set the operation mode of ATIS (RAY230E only).

3.5.30.1 Selecting the Menu Operation

To initiate the Menu function:

1. Press the FUNC key followed by the MENU key. **Mn** appears on the 7-segment display and NAVSTAT is shown on the dot matrix display.
2. To scroll through these first level menu items, press the SQ UP/DOWN key. The indicators alternate between NAVSTAT, DSC, and SETTING.
3. Select the desired operation and press the ENT key to enter that particular menu item.

To exit the Menu operation, press and hold the CLR key for 3 seconds.

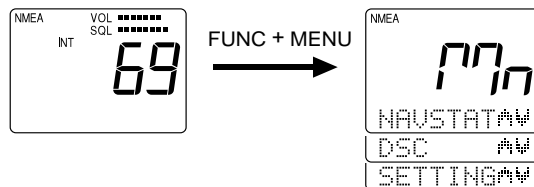

3.5.30.2 NAVSTAT Operation

This operation indicates on the LCD display the position information that has been input via NMEA or SeaTalk or has been manually input using the LL/ENT function.

To view current position information:

1. Press the FUNC key followed by the MENU key to initiate the Menu operation.
2. Select NAVSTAT and press the ENT key. The following five items are automatically displayed at 3-second intervals in the following order:
 1. Latitude
 2. Longitude
 3. UTC Time
 4. UTC Date (Y/M/D)
 5. Position source (GPS, DIFF GPS, NO GPS)

This data is for viewing only and can not be altered. Manual position entry is done in the DSC menu as outlined in Section 3.5.30.3.2

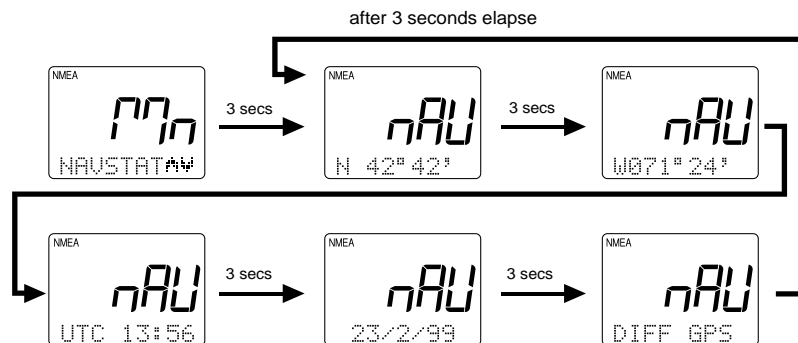

To return to the main menu screen, again press FUNC followed by MENU.
To exit the Menu operation, press and hold the CLR key for 3 seconds.

3.5.30.3 DSC Operation

DSC operation includes the manual entry of latitude/longitude, listing of other ship's MMSI numbers for ship-to-ship and ship-to-shore communications, and listing of Group MMSI number.

To initiate the DSC operation:

1. Press the FUNC key followed by the MENU key to initiate the Menu operation.
2. Select DSC and press the ENT key. The 7-segment display shows **dSC** and the dot matrix display shows L/L ENT.

The DSC Main Menu is made up of NATURE, L/L ENT, PHNBOOK, and GROUP submenus.

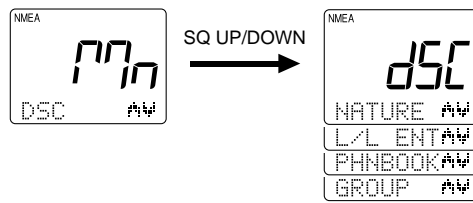

3. Press the SQ UP/DOWN key until the desired operation is displayed:

NATURE	Select type of Distress Call
L/L ENT	Manual entry of latitude/longitude
PHNBOOK	Listing of MMSI numbers
GROUP	Listing of Group MMSI numbers

Note: The *GROUP* selection only appears if a Group MMSI number has been entered.

4. Press the ENT key to submit.

3.5.30.3.1 Selecting Distress Call Type (NATURE)

This menu item is used to select the nature of a distress call before the call is sent. The selected information will be sent along with the distress call.

To select the nature of the distress that will be included with the call:

1. As described in section 3.5.30.3 DSC Operation above, select the DSC operation NATURE.
2. Press the ENT key to initiate the process. The 7-segment display shows **nAt** and the dot matrix display shows FIRE.
3. Use the SQ UP/DOWN key to select the type of distress.

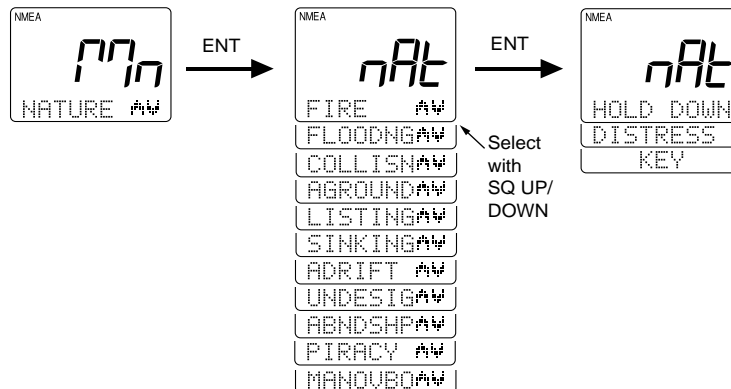

4. After selecting the desired distress type, press ENT. You are prompted to press the DISTRESS key.
5. To send the distress call at this time, press and hold the DISTRESS button. Follow the instructions on the display or the steps described in Section 3.5.26.7.
6. To cancel the distress call, press and hold CLR for 3 seconds.

3.5.30.3.2 Manual Entry of Latitude/Longitude (L/L ENT)

This operation is used to manually enter the latitude/longitude and UTC time when normal SeaTalk or NMEA input of the position information is not available. The radio will sound a 5-second-long alert tone every four hours to remind you to update your position.

1. As described in section 3.5.30.3 DSC Operation above, select the DSC operation L/L ENT. The 7-segment display shows **L L**, while the dot matrix display shows the latest latitude data.
2. Press one of the following keys to initiate the corresponding operation:

Keys	Action
0 - 9 keys	Changes the flashing numeric value (see step 3), then advances to the next digit's place.
ENT key	Advances from Latitude, to Longitude, to UTC.
CLR key	Returns to the previous subject item.
SQ UP/ DOWN key	For Latitude, alternates between N and S. For Longitude, alternates between E and W. For UTC, no effect.

3. The subject items can be changed in the following order. Numeric values that can be changed are flashing:
 1. Degrees of lat at ten's place
 2. Degrees of lat at unit's place
 3. Minutes of lat at ten's place
 4. Minutes of lat at unit's place
 5. Degrees of lon at hundred's place
 6. Degrees of lon at ten's place
 7. Degrees of lon at unit's place
 8. Minutes of lon at ten's place
 9. Minutes of lon at unit's place
 10. Hours of UTC at ten's place
 11. Hours of UTC at unit's place
 12. Minutes of UTC at ten's place
 13. Minutes of UTC at unit's place
4. After changing the subject item, the display scrolls from latitude to longitude to UTC. To submit the change of the position data as shown in the display, press the ENT key. The unit exits Menu mode and returns to normal operation.

To exit the Menu operation, press and hold the CLR key for 3 seconds. The following illustration shows an example of the operation:

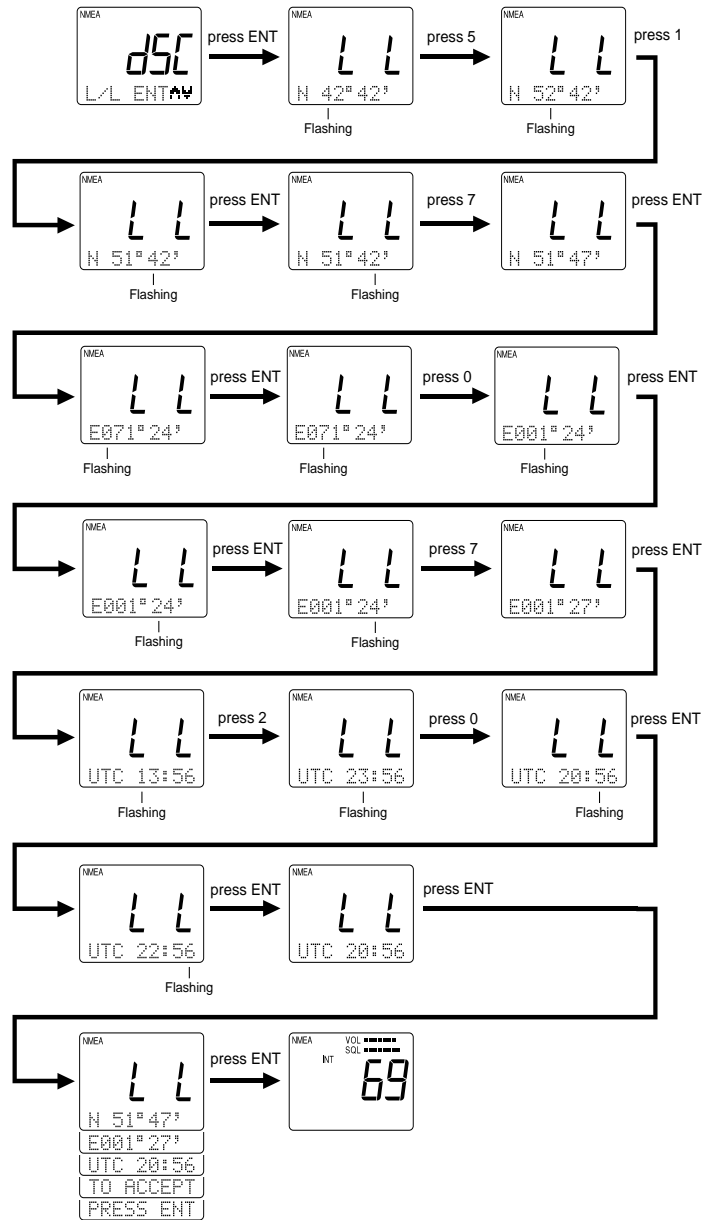

3.5.30.3.3 Modifying the MMSI Number List (PHNBOOK)

This operation is used to modify the "phonebook" lists of MMSI numbers used for DSC Individual Calls. Two lists are available: one for Ship stations and one for Shore stations. Each list allows you to register the MMSI number and nickname for up to 20 Ship and 20 Shore stations.

1. As described in section 3.5.30.3 DSC Operation above, select the DSC operation PHNBOOK.
2. Press the ENT key to initiate the process. The 7-segment display shows **Phb** and the dot matrix display shows SHIP.

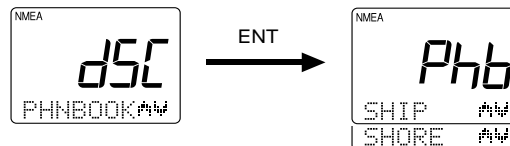

3. Use the SQ UP/DOWN key to select between SHIP or SHORE.
4. Press the ENT key to turn to submit your selection.

Modifying the List of Ship Stations

In this operation, a ship is added to or deleted from the phonebook list for ship stations.

1. When SHIP is displayed, press the ENT key. The 7-segment display shows SHP, while on the dot matrix display shows ENTRY.
2. The ENTRY selection is used to add an item to the list. Press the ENT key to accept.

The list can hold a maximum of 20 entries. If a list is already full or if the list becomes full during this process, operation returns to the EDIT mode and the message PHNBOOK IS FULL HOLD DOWN CLR KEY is scrolled.

3. To delete an item from the list, use the SQ UP/DOWN key to select DELETE and press the ENT key. If no station has yet been registered, the message PHNBOOK IS EMPTY HOLD DOWN CLR KEY is scrolled.

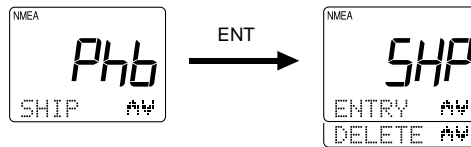

Note: Pressing and holding the CLR key for 3 seconds during either ENTRY or DELETE returns operation to the mode before the Menu operation began.

Adding Ship Stations to the List

To add to the phonebook list for ship stations, input the MMSI number and nickname of the station.

1. To enter the MMSI number, press the corresponding numeric keys (0 through 9). The currently selected location is indicated by a flashing "-" character. Pressing a numeric key enters that value then advances to the next digit's place. To go back by 1 digit, press the CLR key.
2. To enter the nickname, use the numeric keys (0 through 9) to input the associated alpha or numeric value (refer to section 3.2 Controls and LCD Display). The currently selected location is indicated by the flashing "-" character. After inputting the desired letter or numeral, press the ENT key to submit the entry and proceed to the next place.

To go back by 1 digit, press the CLR key.

If no nickname is to be registered, press the ENT key for all characters so that they all display a "-".

3. When the message CONT? Y appears, press the ENT key to submit.

Note: The 0 key will enter only the numeral "0", while the 1 key will alternately enter "1" and "space". The 0 and 1 keys do not have associated alpha characters.

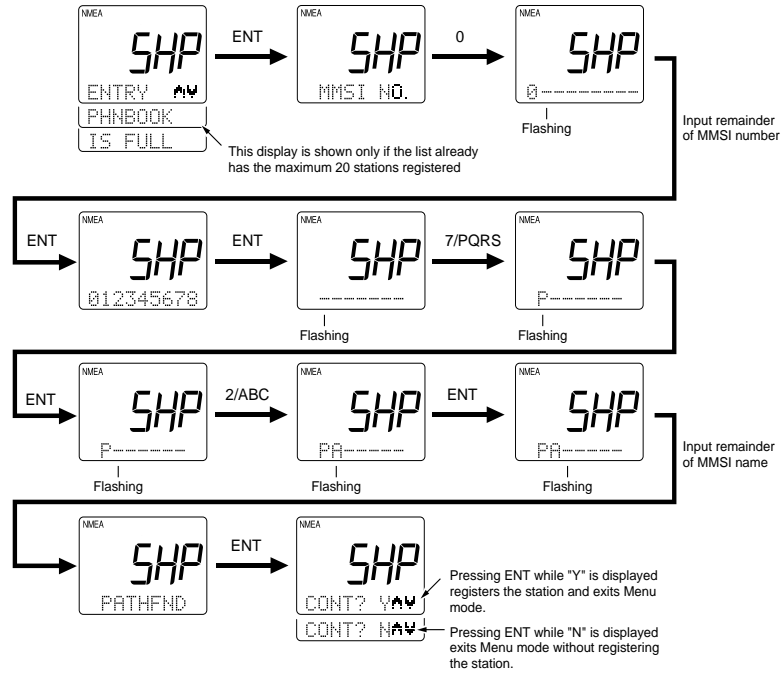

Deleting Ship Stations from the List

When the ship station phonebook is selected, the oldest MMSI number or nickname flashes on the dot matrix display.

1. Press the SQ UP/DOWN key to scroll through the registered stations until the station to be deleted is displayed.
2. Press the ENT key; the message DEL? Y is displayed.
3. Press the ENT key to process the deletion and exit the Menu operation.

To exit without deleting, press the SQ UP/DOWN key until DEL? N is displayed. If the list has no stations entered, the message PHNBOOK IS EMPTY HOLD DOWN CLR KEY is displayed. Press and hold the CLR key for 3 seconds to exit Menu mode.

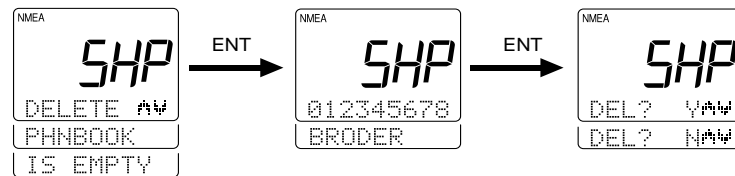

Modifying the List of Shore Stations

In this operation, a shore (coast) station is added to or deleted from the phonebook list.

1. When SHORE is displayed, press the ENT key. **SHO** appears on the 7-segment display, while on the dot matrix display shows ENTRY.
2. The ENTRY selection is used to add an item to the list. Press the ENT key to accept.
The list can hold a maximum of 20 entries. If a list is already full or if the list becomes full during this process, operation returns to the EDIT mode and the indicator PHNBOOK IS FULL is displayed.
3. To delete an item from the list, use the SQ UP/DOWN key to select DELETE and press the ENT key. If no station has yet been registered, the message PHNBOOK IS EMPTY is displayed.

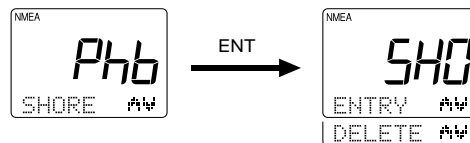

Note: Pressing and holding the CLR key for 3 seconds during either ENTRY or DELETE returns operation to the mode before the Menu operation began.

Adding Shore Stations to the List

To add to the phonebook list for shore stations, input the MMSI number and nickname of the station.

1. To enter the MMSI number, press the corresponding numeric keys (0 through 9). The currently selected location is indicated by a flashing "-" character. Pressing a numeric key enters that value then advances to the next digit's place. To go back by 1 digit, press the CLR key.
2. To enter the nickname, use the numeric keys (0 through 9) to input their associated alpha or numeric value (refer to section 3.2 Controls and LCD Display). The currently selected location is indicated by a flashing "-" character. After inputting the desired letter or numeral, press the ENT key to submit the entry and proceed to the next place.
3. When the message CONT? Y appears, press the ENT key to submit the registration.

To go back by 1 digit, press the CLR key. If no nickname is to be registered, press the ENT key for all characters so that they all display a "-".

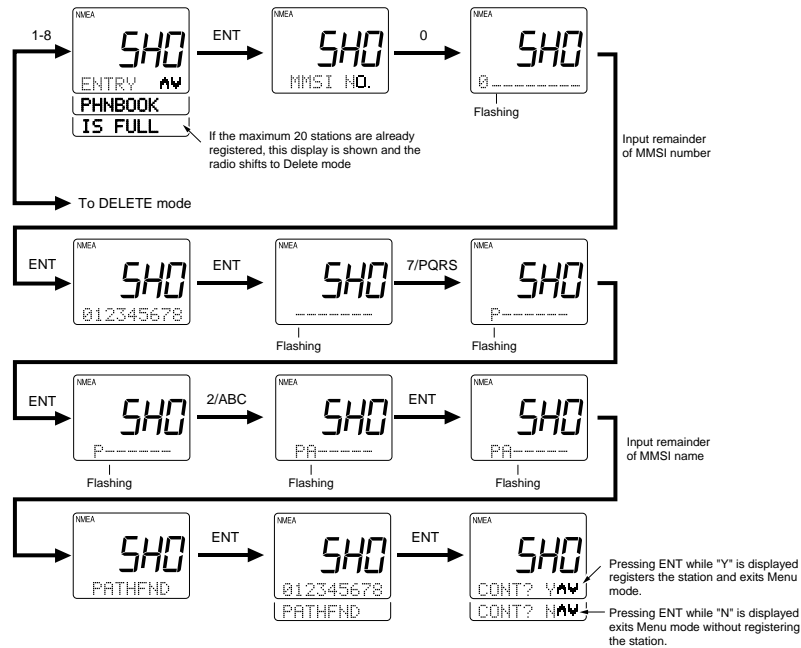

Note: The **0** key will enter only the numeral "0", while the **1** key will alternately enter "1" and "space". The **0** and **1** keys do not have associated alpha characters.

Deleting Shore Stations from the List

When the shore station phonebook is selected, the oldest MMSI number or nickname flashes on the dot matrix display.

1. Press the SQ UP/DOWN key to scroll through the registered stations until the station to be deleted is displayed.
2. Press the ENT key; the message DEL? Y is displayed.
3. Press the ENT key to process the deletion and exit the Menu operation.

To exit without deleting, press the SQ UP/DOWN key until DEL? N is displayed. If the list has no stations entered, the message PHNBOOK IS EMPTY HOLD DOWN CLR KEY is displayed. Press and hold the CLR key for 3 seconds to exit Menu mode.

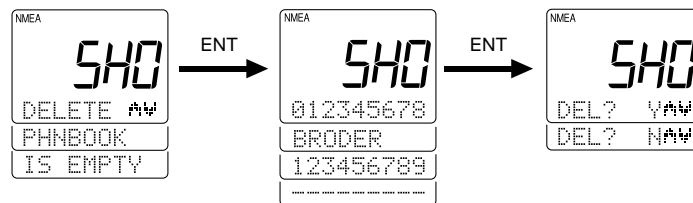

3.5.30.3.4 Modifying the MMSI Group Number (GROUP)

This operation modifies the MMSI number to be used in receiving a Group Digital Selective Call.

1. As described in section 3.5.30.3 DSC Operation above, select the DSC operation GROUP.
2. Press the ENT key to initiate the process. The 7-segment display shows GrP and the dot matrix display shows ENTRY.
3. Use the SQ UP/DOWN key to alternate between ENTRY or DELETE.
4. Press the ENT key to turn to submit the desired selection.

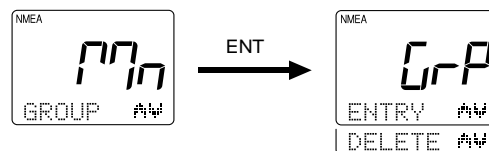

Adding a Group to the List

To add a group to the list, select ENTRY then press the ENT key. Use the numeric keys (0 through 9) to input desired group number. The currently selected location is indicated by a flashing "-" character. Pressing a numeric key enters that value then advances to the next place. To go back by 1 digit, press the CLR key.

After the last position has been filled, the message CONT? Y appears.

Press ENT to register the group and exit the Menu operation. To exit without registering, press SQ UP/DOWN until DEL? N is displayed. Press the ENT key and operation returns to mode before the Menu operation.

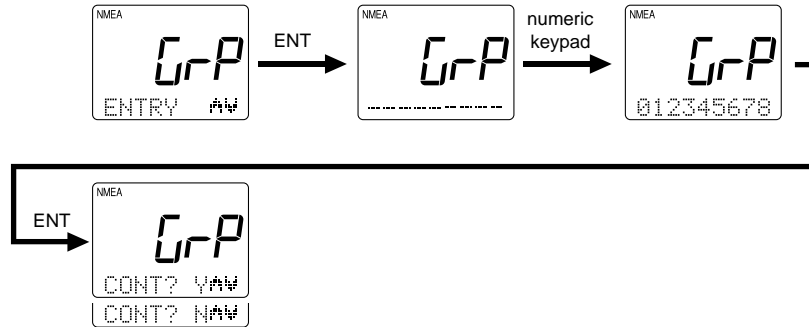

Deleting a Group from the List

Use the SQ UP/DOWN key to select DELETE. To delete the contents indicated, press the ENT key and the message DEL? Y is displayed. Press the ENT key to process the deletion and exit the Menu operation. To exit without deleting, press the SQ UP/DOWN key until DEL? N is displayed. Press the ENT key and operation returns to the mode before the Menu operation began.

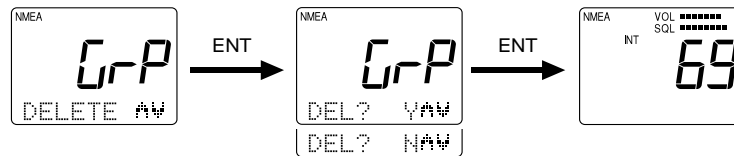

3.5.30.4 Setting Operation (RAY230)

This operation sets the function features of the unit, the name of the Intercom station, the unit's MMSI number, and the call tone/type of the siren.

1. Press the FUNC key followed by the MENU key to initiate the Menu mode. **Mn** appears on the 7-segment display and NAVSTAT appears on the dot matrix display.
2. Press the SQ UP/DOWN key to select SETTING.
3. Press the ENT key. The message SET appears on the 7-segment display and INTERCM appears on the dot matrix display. Pressing the SQ UP/DOWN key alternates between the following:

INTRCM	selects the Intercom setting
MYMMSI	selects the MMSI number for this unit
SIREN	selects the Fog Alert siren setting

4. Select the desired operation and press the ENT key to submit your selection.

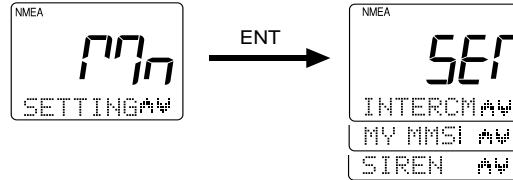

To exit the Setting operation, press and hold the CLR key for 3 seconds.

3.5.30.4.1 Intercom Set Up

During an Intercom call, the name of the handset being called (or the name of the handset initiating the call) appears in the dot matrix display. Initially, this name is HANDSET 1, HANDSET 2, or HANDSET 3. This identifier name and the alert tone sounded when receiving an Intercom call can be chosen from among four types.

To change the Station name or Intercom tone:

1. Select the INTRCM operation as described above in section 3.5.30.4 Setting Operation (RAY230).
2. Press the ENT key. The 7-segment display shows **IC1** and the dot matrix display indicates STATN 1.

3. Press the SQ UP/DOWN key scroll to STATN 2 and STATN 3. The indication on the 7-segment display changes to **IC2** or **IC3**, respectively.

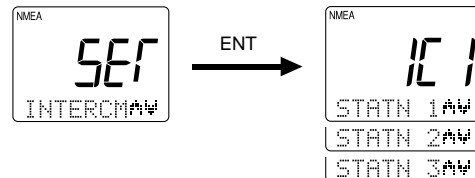

4. When the desired station name is displayed, press the ENT key to submit.
5. To enter the new station name, use the numeric keys (0 through 9) to input the associated alpha or numeric value (refer to section 3.2 Controls and LCD Display). The currently selected location is indicated by the flashing "-" character. After inputting the desired letter or numeral, press the ENT key to submit the entry and proceed to the next place. To go back by 1 digit, press the CLR key.
6. After entering all the desired characters, press the ENT key. The message RING 1 is now displayed, prompting you to setup the ring tone.
7. To change the tone, press the SQ UP/DOWN key to alternate between RING 2, RING 3, and RING 4. As you scroll, the corresponding call tone sounds from the handset.
8. When you hear the desired call tone, press the ENT key. The contents of your changes are scrolled across the LCD.
9. If the contents are acceptable, press the ENT key to confirm. The message CONT? Y is displayed.
10. Press the ENT key to register the changes.

To exit without making the changes, press the SQ UP/DOWN key until DEL? N is displayed. Press the ENT key and operation returns to the mode before the Menu operation began.

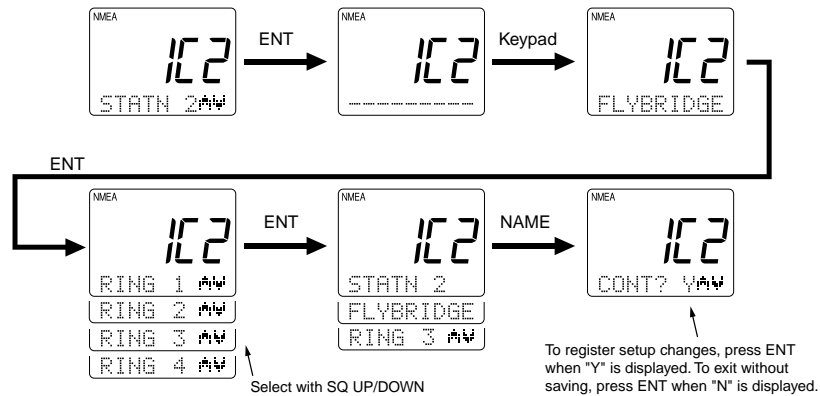

3.5.30.4.2 MMSI Number Set Up

This operation stores the MMSI number required for DSC communications, including distress calls. You can request an MMSI number when you apply for a radio license. If your vessel does not require a license, you may obtain an MMSI by contacting either BoatUS (www.boatus.com) or MariTEL (www.maritelusa.com).

Notes:

- This is a one time operation. Once the MMSI number has been programmed, you will not be able to change it.
- Until the MMSI number is programmed, all DSC functionality is disabled. Pressing the **INDV**, **ALL SHIP**, and **DISTRESS** buttons will only sound an error alert.

To register the MMSI Number into memory:

1. Select the MY MMSI function as described above in Section 3.5.30.4 Setting Operation (RAY230).
2. Press the ENT key. **MS** appears on the 7-segment display and the dot matrix display scrolls PLEASE PROGRAM MMSI NO.
3. Press ENT. Nine underscore characters appear, which are placeholders for the 9 digits of the MMSI number. The first character place to be input is flashing.

Pressing the following keys initiate the corresponding operation:

4. Input your MMSI number using the numeric keypad.
5. Press the ENT key. The message ENT - ACCEPT, CLR - EXIT scrolls across the display.

Keys	Action
0 - 9 keys	Changes the flashing numeric value, then advances to the next digit's place.
ENT key	Advances the (flashing) subject item to the next one without changing the numeric value. Advances to the next screen after entering the last (ninth) digit.
CLR key	Returns to the previous subject item. Pressing and holding for 3 seconds exits the operation and returns to the mode before the Menu Operation began.

6. Press the ENT key to submit the number. The message ENTER MMSI NO. AGAIN is displayed.
7. Press ENT. The nine underscore placeholders appear once more.
8. Again input the MMSI number with the numeric keypad.
9. Press ENT to submit. If the second MMSI number you input matches the first, the message ENT - ACCEPT, CLR - EXIT is again displayed.

Note: *If the two MMSI numbers don't match, the message MMSI NO. NOT MATCH PRESS ENT scrolls across the display. Press ENT to exit the Menu mode and try again from step 1.*

10. Press ENT to verify. The message ENT - STORE, CLR - EXIT is displayed.
11. Press ENT one last time to register the MMSI number in memory. Operation returns to the mode before the Menu mode began.

To exit without making changes at any time, press and hold CLR for 3 seconds.

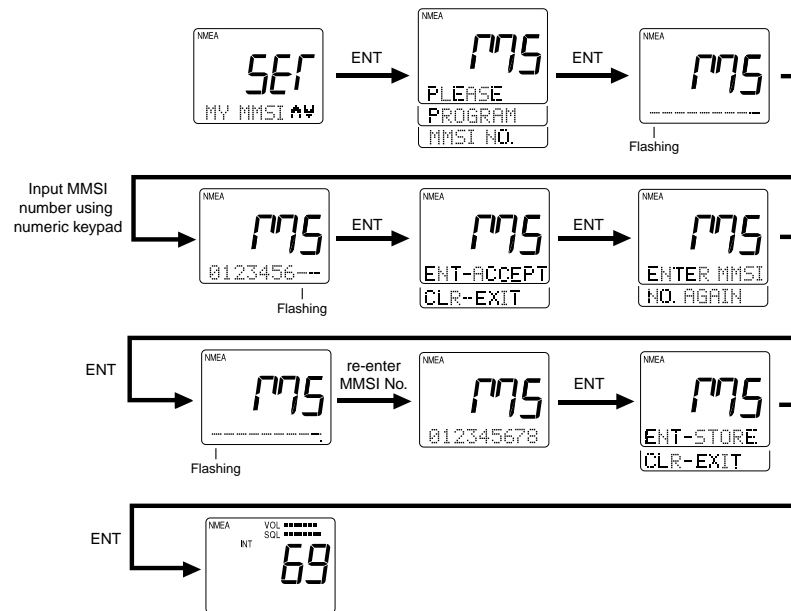

3.5.30.4.3 Siren Set Up

This operation changes the tone of the siren that sounds from the Hailer Horn speaker when the SIREN option is selected in Fog/Siren mode, as described in Section 3.5.18.

CAUTION:

The siren sounds available in this radio are for recreational purposes only. It is your responsibility to exercise caution and common prudence when emitting these siren sounds.

To select the siren tone:

1. Select the SIREN function as described above in Section 3.5.30.4 Setting Operation (RAY230).
2. Press the ENT key. **Sir** appears on the 7-segment display, the dot matrix display indicates CADENC1, and the corresponding call tone sounds from the handset.
3. To change the tone, press the SQ UP/DOWN key to alternate between CADENC2, CADENC3, and CADENC4. As you scroll, the corresponding siren tone sounds from the handset. The table that follows describes the type of tone emitted and the procedure for sounding the siren while in Fog/Siren mode. **Mn** is shown on the 7-segment display and NAVSTAT appears on the dot matrix display.

Name	Sound	Operating Siren in Fog/Siren Mode
CADENC1	"Hi-Lo"	Press and hold PTT switch to emit sound. Release PTT to stop.
CADENC2	Siren	Press and hold PTT switch to emit sound. Release PTT to stop.
CADENC3	Whelp	Press and hold PTT switch to emit sound. Release PTT to stop.
CADENC4	Air Horn	Press and hold PTT switch to emit sound. Release PTT to stop.

4. When the desired call tone is heard, press the ENT key to accept. The message CONT? Y is displayed.
5. Press the ENT key to register the changes.

To exit without making the changes, press the SQ UP/DOWN key until DEL? N is displayed. Press the ENT key and operation returns to the mode before the Menu operation began.

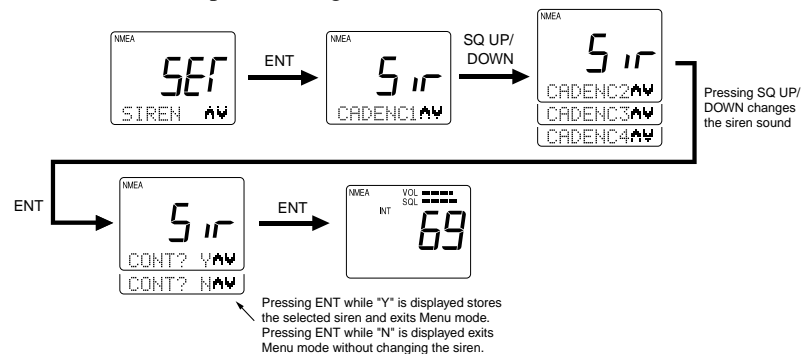

Note: If your RAY230/E cannot emit siren sounds, this feature may have been disabled in your radio.

3.5.30.5 Setting Operation (RAY230E)

This operation sets the function features of the RAY230E: the name of the Intercom station, the ATIS ID number and on/off state, the MMSI number, the Tri-Watch function, and the call tone type of the siren.

1. Press the FUNC key followed by the MENU key to initiate the Menu mode. **Mn** is shown on the 7-segment display and NAVSTAT appears on the dot matrix display.
2. Press the SQ UP/DOWN key to select SETTING.
3. Press the ENT key. The message SET appears on the 7-segment display and INTERCM appears on the dot matrix display. Pressing the SQ UP/DOWN key alternates between the following:

INTRCM	selects the Intercom setting
MYATIS	registers the ATIS ID number
MYMMSI	registers the MMSI number
TRI	selects the Tri-Watch operation
ATIS	turns the ATIS function ON or OFF
SIREN	selects the siren setting

Note: The ATIS selection only appears if this option has been enabled by the dealer.

4. Select the desired operation and press the ENT key to submit your selection.

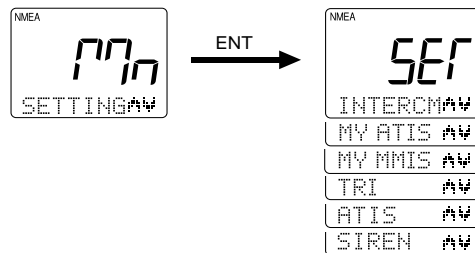

3.5.30.5.1 Intercom Set Up

The operation is identical to the Intercom operation described for the RAY230 in section 3.5.30.4.1.

3.5.30.5.2 MY ATIS Set Up

This operation stores the ATIS number required for the Automatic Transmission Identification System used in inland waterways of some European countries. You can request an ATIS number when you apply for a radio license.

Regulations in some regions may not allow end users to program their own ATIS number. If this unit was purchased to be used in such a region, this function will be disabled and the programming must be done by your Raymarine distributor.

Notes:

- *This is a one time operation. Once the ATIS number has been programmed, you will not be able to change it.*
- *The ATIS ID number is a ten digit number, beginning with a "9". The MY ATIS set up process has you input only the last 9 digits. The leading "9" is automatically input for you.*

To register the ATIS Number into memory:

1. Select the MY ATIS function as described above in Section 3.5.30.5 Setting Operation (RAY230E).
2. Press the ENT key. The 7-segment display shows **AId** and the dot matrix display scrolls PLEASE PROGRAM ATIS ID.
3. Press ENT. Nine underscore characters appear, which are placeholders for the last 9 digits of the ATIS number. The first character place to be input is flashing.

Pressing the following keys initiate the corresponding operation:

Keys	Action
0 - 9 keys	Changes the flashing numeric value, then advances to the next digit's place.
ENT key	Advances the (flashing) subject item to the next one without changing the numeric value. Advances to the next screen after entering the last (ninth) digit.
CLR key	Returns to the previous subject item. Pressing and holding for 3 seconds exits the operation and returns to the mode before the Menu Operation began.

4. Input your ATIS number using the numeric keypad.
5. Press the ENT key. The message ENT - ACCEPT, CLR - EXIT scrolls across the display.
6. Press the ENT key to submit the number. The message ENTER ATIS ID AGAIN is displayed.
7. Press ENT. The nine underscore placeholders appear once more.
8. Again input the ATIS number with the numeric keypad.
9. Press ENT to submit. If the second ATIS number you input matches the first, the message ENT - ACCEPT, CLR - EXIT is again displayed.

Note: *If the two ATIS numbers don't match, the message ATIS ID NOT MATCH PRESS ENT scrolls across the display. Press ENT to exit the Menu mode and try again from step 1.*

10. Press ENT to verify. The message ENT - STORE, CLR - EXIT is displayed.
11. Press ENT one last time to register the ATIS number in memory. Operation returns to the mode before the Menu operation began.

To exit without making changes at any time, press and hold CLR for 3

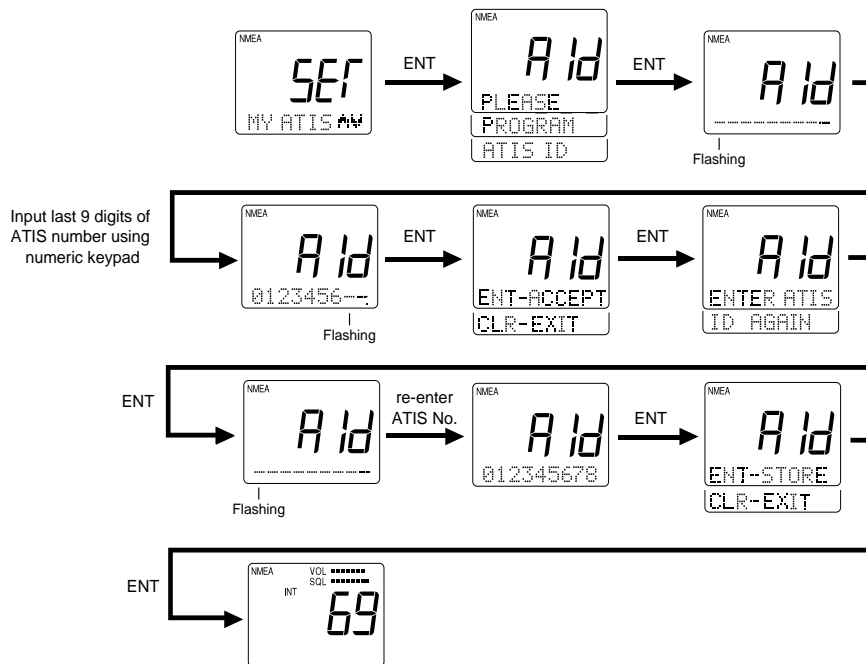

3.5.30.5.3 MY MMSI Set Up

The operation is identical to the MMSI set up operation described for the RAY230 in section 3.5.30.4.2 MY MMSI Set Up.

Note: Regulations in some regions may not permit end users to program their own MMSI number. If this unit was purchased to be used in such a region, this function will be disabled and the programming must be done by your dealer/distributor.

3.5.30.5.4 Tri-Watch Set Up

This operation selects whether the Weather Channel is monitored during Tri-Watch state in the US mode or the Multi-Call Channel is monitored during Tri-Watch state in the INT mode.

Note: Access to the US frequency group is only available with a software upgrade from your dealer. Otherwise this feature is disabled.

To change the monitored channel:

1. Per the description in section 3.5.30.8 Setting Operation above, select TRI.
2. Press the ENT key. **Tri** appears on the 7-segment display and TRI WX appears on the dot matrix.
3. Press the SQ UP/DOWN key to toggle between TRI MUL for Multi-Call and TRI WX for Weather Channel.
4. After selecting the desired operation, press the ENT key.
5. If the setting is acceptable, press the ENT key to confirm. The message CONT? Y is displayed.
6. Press the ENT key to register the setting.

To exit without making changes, press the SQ UP/DOWN key until DEL? N is displayed. Press the ENT key and operation returns to the mode before the Menu operation began.

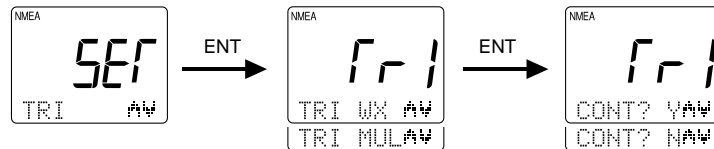

3.5.30.5.5 ATIS Set Up

This operation determines whether to effect ID transmission of ATIS after the PTT switch is released.

To set the ATIS function:

1. Per the description in Section 3.5.30.5 Setting Operation (RAY230E) above, select ATIS.
2. Press the ENT key. The message ATS is shown on the 7-segment display and ATIS OFF appears on the dot matrix.
3. Press the SQ UP/DOWN key to toggle between ATIS ON and ATIS OFF.
4. After selecting the desired operation, press the ENT key.
5. If the setting is acceptable, press the ENT key to confirm. The message CONT? Y is displayed.
6. Press the ENT key to register the setting. When ATIS is ON, the ATIS indicator is illuminated on the LCD.

To exit without making changes, press the SQ UP/DOWN key until DEL? N is displayed. Press the ENT key and operation returns to the mode before the Menu operation began.

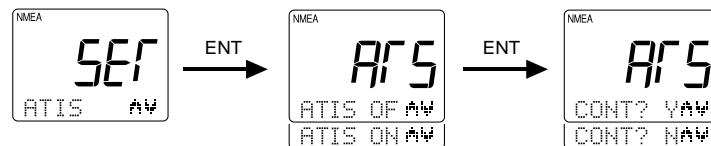

3.5.30.5.6 Siren Set Up

The operation is identical to the Siren set up operation described for the RAY230 in section 3.5.30.4.3 Siren Set Up.

Section 4 Maintenance

4.1 How to Contact Raymarine

The RAY230/RAY320E is designed to provide long periods of trouble-free operation. It is recognized, however, that environmental and other factors may result in a need for occasional service.

In the US

Technical Support **1-800-539-5539 ext. 2444, or**
1-603-881-5200 ext. 2444

You can reach our Technical Support Department Monday to Friday 4:00 AM to 6:00 PM Eastern Standard Time. Our Technical Support Specialists are available to answer installation, operation, and troubleshooting questions about your Raymarine unit.

Accessories and Parts **1-800-539-5539 ext. 2333, or**
1-603-881-5200 ext. 2333

Many Raymarine accessory items and parts are available through your authorized Raymarine dealer. However if you are in need of an item not available through your retailer feel free to contact our Customer Service department Monday to Friday 8:15 AM to 5:00 PM Eastern Standard Time. If you are uncertain about what item to choose for your Raymarine unit please contact our Technical Support Department Prior to placing your order at 1-800-539-5539 ext. 2065.

In the unlikely event your Raymarine unit should develop a problem please contact the Raymarine dealer from where the unit was purchased. Your Raymarine dealer is best equipped to handle your service needs.

Service may also be obtained by returning your unit to Raymarine's Product Repair Center at the address below.

Raymarine, Inc.
Product Repair Center
22 Cotton Road, Unit D
Nashua, NH 03063-4219

In Europe

In Europe, Raymarine support, service and accessories may be obtained from your authorized dealer, or contact:

Raymarine Limited
Anchorage Park
Portsmouth, Hampshire
England PO3 5TD
Tel +44 (0) 23 9269 3611
Fax +44 (0) 23 9269 4642

Technical Support Tel +44 (0) 23 9269 3611
Fax +44 (0) 23 9269 4642

The Technical Services Department handles inquiries concerning installation, operation, fault diagnosis and repair.

Accessories and Parts

Raymarine accessory items and parts are available through your authorized Raymarine dealer. Please refer to the lists of component part numbers and optional accessories in Section 2.2 of this handbook and have the Raymarine part number ready when speaking with your dealer. If you are uncertain about what item to choose for your Raymarine unit, please contact our Customer Services Department prior to placing your order.

Worldwide Support

Please contact the authorized distributor in your country. A list of worldwide distributors is supplied with your unit and on the Raymarine website.

On the Internet

You can also reach us on the Raymarine World Wide Web site:

www.raymarine.com

Navigate to the **Customer Support** page, which provides links for:

- Finding Factory Service locations and Authorized Dealers near you
- Accessing handbooks in Adobe Acrobat format
- Searching questions and answers in our solution database by product, category, keywords, or phrases
- Submitting a question to our technical support staff, who reply to you by e-mail
- Logging in to check the status of your questions, modify your answer update notifications, or update your personal profile

Questions can be sent directly to our Technical Support Department on the Customer Support page by clicking **Ask Raymarine**.

4.2 Preventative Maintenance

The RAY230/230E has been constructed to be virtually maintenance free. Your attention to a few basic points should assure many years of service.

1. Although the unit is waterproof, always keep the unit as dry as possible.
2. Clean the exterior of the unit with a tissue or soft non-abrasive cloth.

CAUTION

Do not use solvents or other chemicals for cleaning this equipment.

3. Inspect the radio case and antenna for any physical damage.

4.3 Specifications

4.3.1 Transmitter

Channels	All available US, International, and Canadian VHF Marine Band
Frequency Stability	+/- 10 PPM (+/- 0.001%) (-20°C to +50°C)
Frequency Range	156.025 to 157.425 MHz
Channel Spacing	25 kHz increments
Power Output	25 W switchable to 1W into 50 ohms at 13.6 VDC
Modulation	Frequency modulated 16F3 (+/-4.5 kHz at 1000 Hz)
Mod. Audio Response	Shall not vary +/-3dB from true 6dB pre-emphasis from 300 to 2500 Hz, reference 1000 Hz. Audio frequencies 3-20 kHz shall be attenuated (at 1 kHz by 60 log f/3 dB. Above 20 kHz by 50 dB)
FM Hum & Noise level	Less than -40 dB below audio
Audio Distortion	Less than 10 % at 1 kHz for 3 kHz deviation
Spurious & Harmonic	Attenuated at least 43+10 log Po (below rated radiated carrier Emissions power) per FCC Rules Part 2 & 80
Antenna Impedance	50 ohms
Transmitter Protection	Shall survive open or short circuit of antenna system without damage (10 min. test)

4.3.2 Receiver

Channels	All available US, International, and Canadian VHF Marine Band
Frequency Range	156.025 to 163.275 MHz in 25 kHz increments
Frequency Stability	+/- 10 PPM (+/- 0.001%) from -20°C to +50°C
Usable Sensitivity	0.25 μ V for 12 dB (SINAD)
Squelch Sensitivity	0.2 μ V or better
Threshold	1.0 μ full squelch
Adjacent CH Rejection	70 dB
Spurious Image Rejection	70 dB
Intermodulation Rejection	70 dB
Audio Output	3.5 watts or more at 10% or less distortion into 4 ohm load (internal)
Hum & Noise in Audio	Less than -40 dB

4.3.3 Operating Requirements

Input Voltage	13.6 VDC +/- 15% (11.6 to 15.6 VDC)
Current Required	Less than 6 amps at 25 watts
Transmit	Less than 2 amps at 1 watt
Temperature Range	-4°F to +122°F (-20°C to +50°C)
Duty Cycle	Continuous, 80% receive, 20% transmit (max 10 min, @25°C)
Relative Humidity	80%
Water Protection	To CFR-46 for Base Station and External Speaker. To JIS-7 for Full Function Handset (submersible to 1m for at least 30 minutes)

4.3.4 Radio Dimensions

Base Station Transceiver

Height	2.63 inches (67 mm)
Width	8.98 inches (228 mm)
Depth	7.04 inches (179 mm)
Weight	Approx. 4 lbs (1.87 kg)

Handset

Height	6.81 inches (173 mm)
Width	2.2 inches (56 mm)
Depth	1.1 inches (28 mm)
Weight	Approx. 0.30 lbs (138 g)

Cradle

Height	1.97 inches (50 mm)
Width	2.52 inches (64 mm)
Length	4.02 inches (102.1 mm)
Weight	Approx. 0.15 lbs (70 g) (without cables)

External Speaker

Height	4.53 inches (115 mm)
Width	4.33 inches (110 mm)
Depth	1.57 inches (40 mm)
Weight	Approx. 0.75 lbs (340 g)

4.4 Drawings

Assembly Drawing

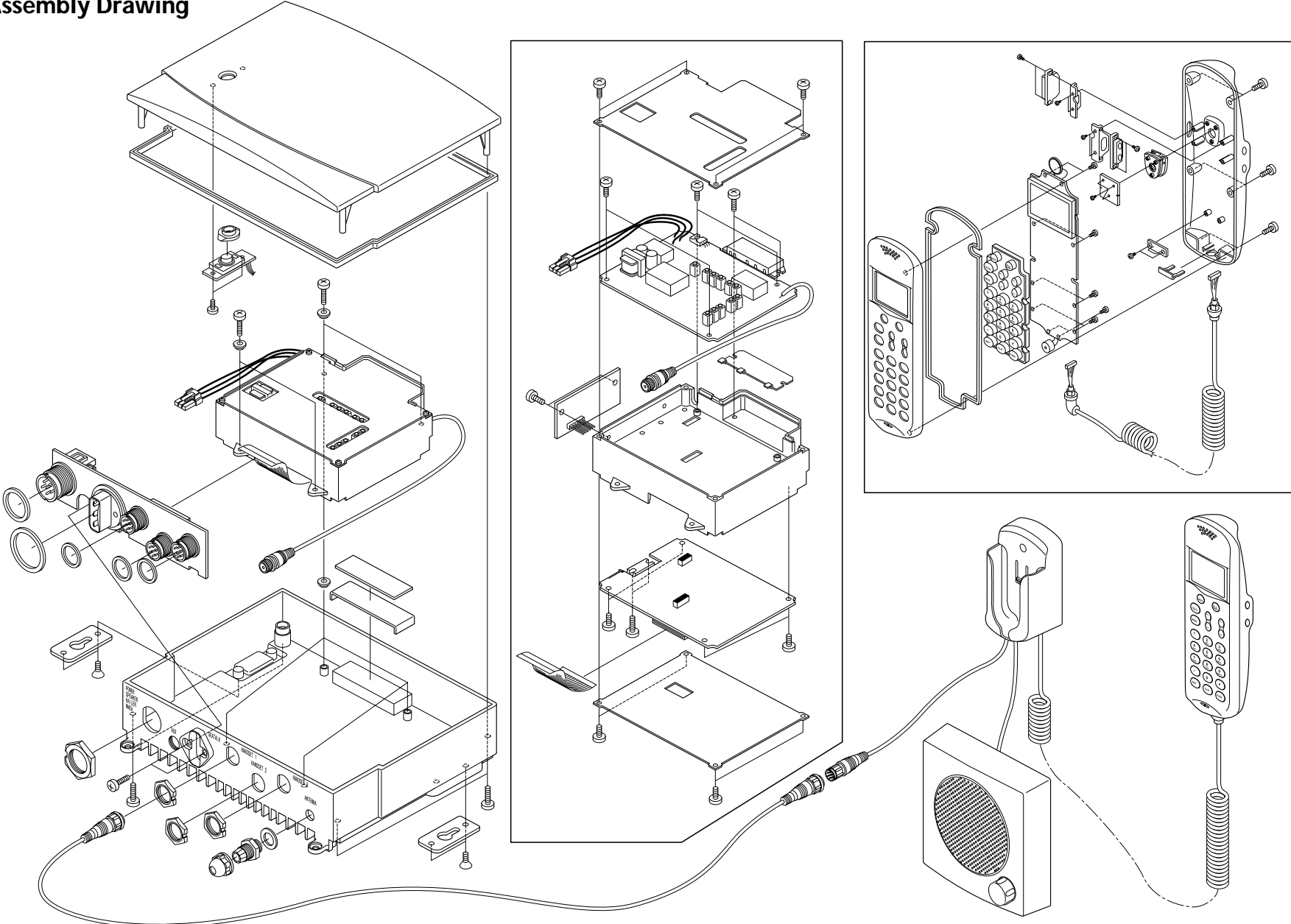

Block Diagram - RF PCB

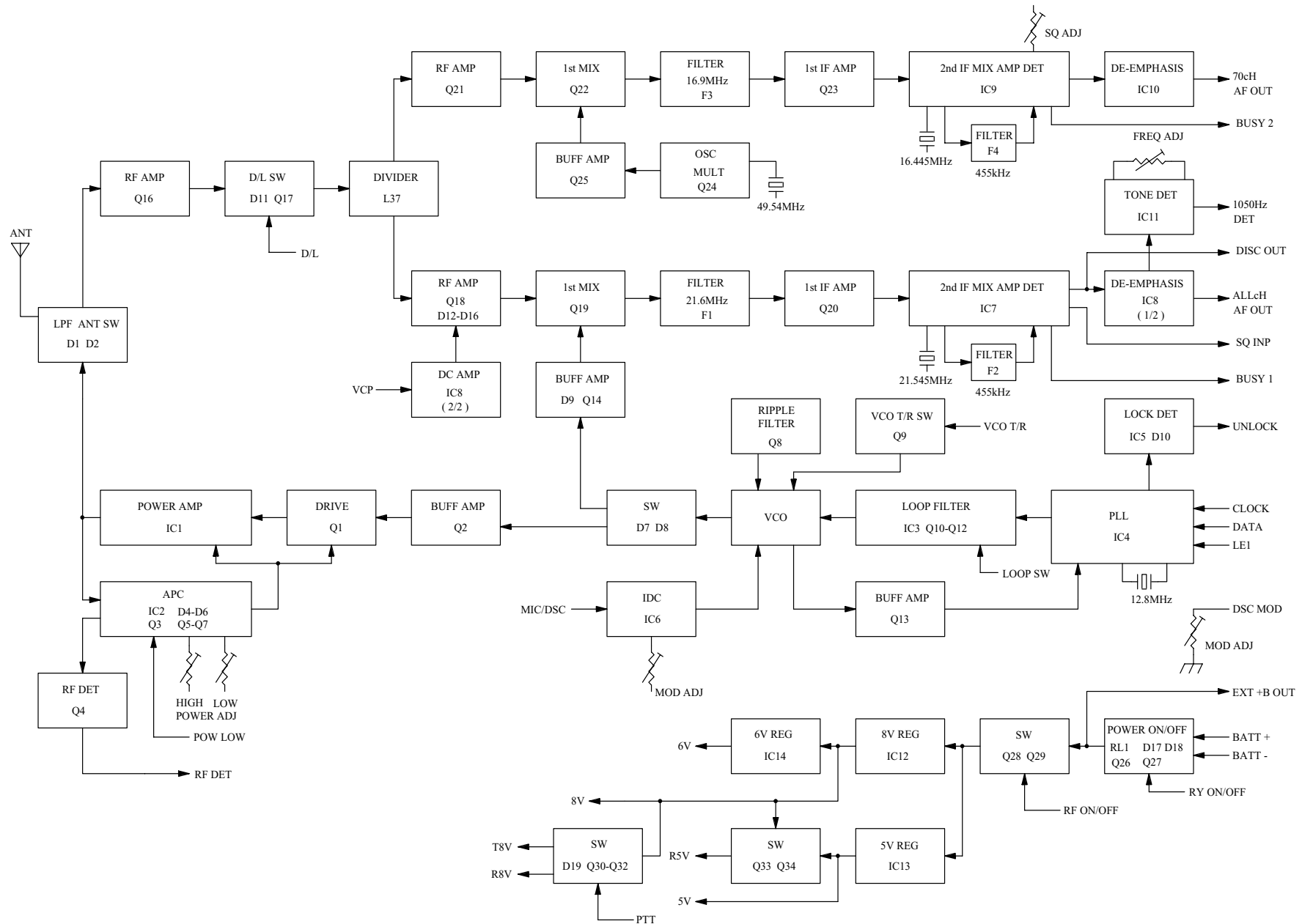

Control PCB

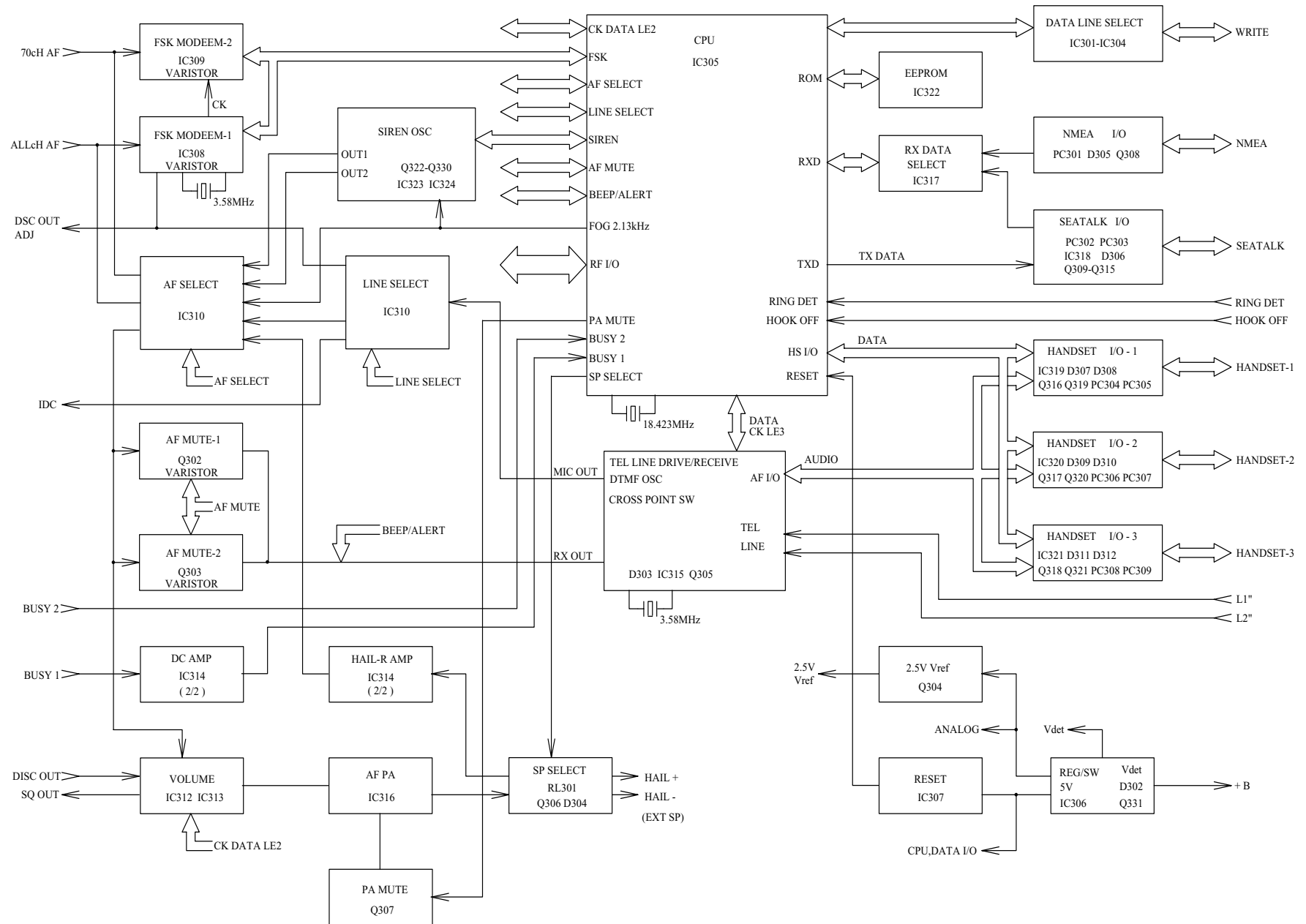

DTMF Interface PCB

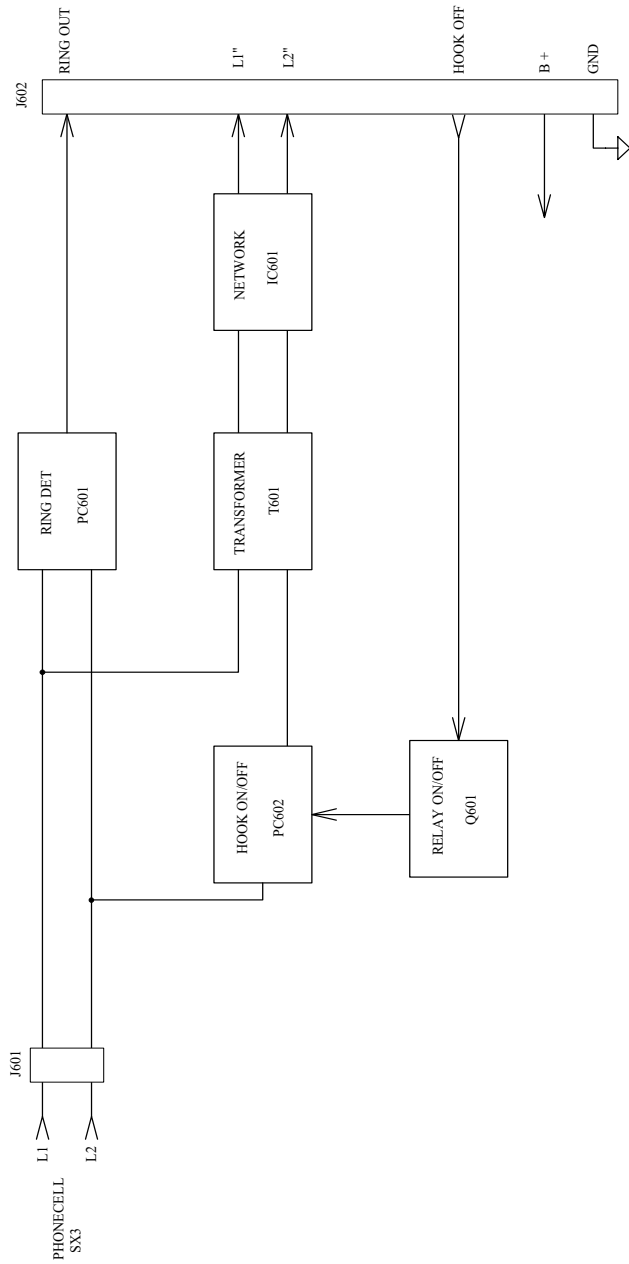

Wiring Diagram

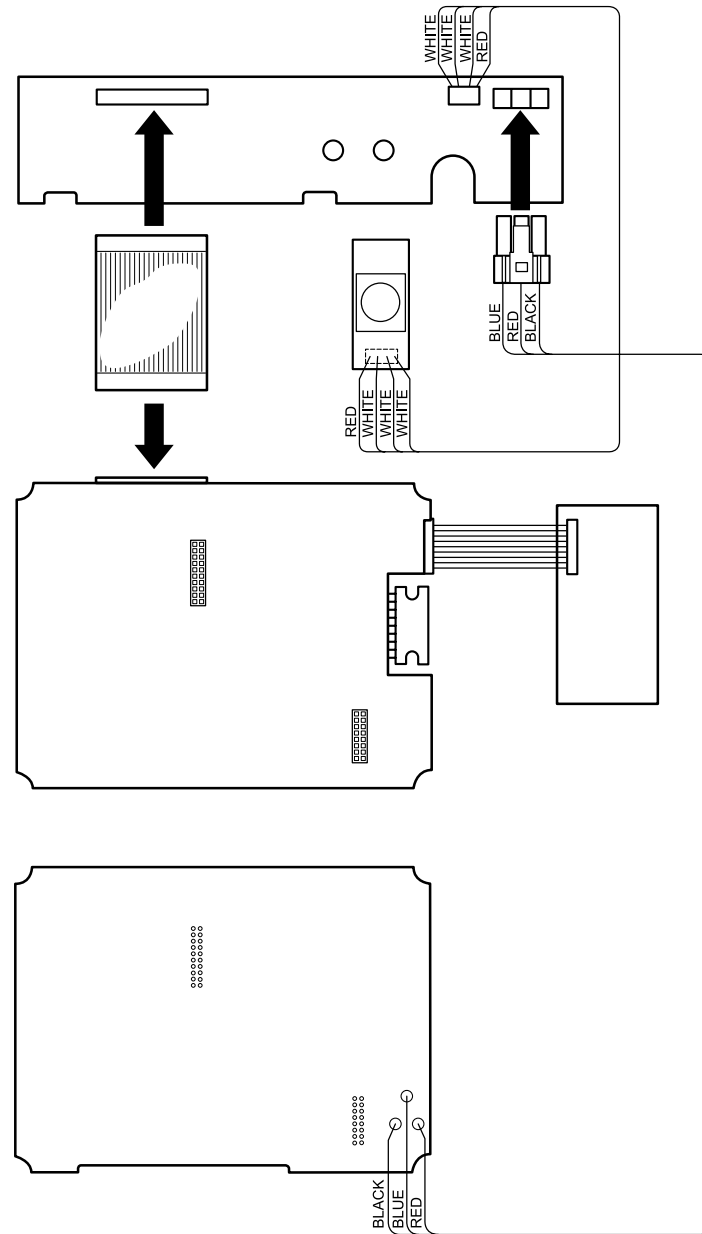

Section 5 Appendix

5.1 FCC Licensing Requirements

Raymarine radios comply with the Federal Communications Commission (FCC) requirements that regulate marine VHF radio usage for the US.

Marine VHF radio users in the US must comply with all applicable FCC rules and regulations, some of which are described here. This information was current at the time this handbook was printed. Up-to-date information, including licensing requirements, can be obtained on the FCC website at:

www.fcc.gov/wtb/marine

Official FCC forms can be obtained on the FCC website at:

www.fcc.gov/formpage.html

Station License

An FCC Ship Radio Station License and Call Sign are not required for most recreational vessels travelling in US waters. Examples of radio equipment that **do not** require a license include: marine VHF radios, any type of Emergency Position Indicating Radio Beacon (EPIRB), any type of radar, GPS or LORAN receivers, depth finders, CB radio, or amateur radio (an amateur license is required). However, you must obtain a license if: (1) you are required by law or treaty to carry a radio on your vessel; (2) your vessel travels to foreign ports; (3) you use marine radio equipment on board your vessel other than the devices listed above. Ships that use MF/HF single side-band radio, satellite communications, or telegraphy must be licensed by the FCC.

If required, you can obtain a Station License by completing FCC Form 605 (available from the FCC website). If no fees are required, mail the completed form to:

Federal Communications Commission
1270 Fairfield Road
Gettysburg, PA 17325-7245

If fees are required, send Form 605 and the required fees to:

Federal Communications Commission
Wireless Bureau Applications
P. O. Box 358130
Pittsburgh, PA 15251-5130

Operator License

An Operator License is not required to operate a VHF Marine Radio within US territorial waters. However, a license is required to operate the radio if you dock in a foreign port (including Canada and Mexico) or leave a foreign port to dock in a U.S. port. You can request a Restricted Radiotelephone Operator Permit from the FCC by filing Form 753.

Remember:

- Maintain a radio watch on Channel 16. Channel 16 is used for distress and safety purposes only.
- VHF Channel 70 is used only for Digital Selective Calling (DSC). It can not be used for general-purpose calling.
- Your VHF transceiver has a high low power switch. Use low power whenever feasible. Unnecessary high-power operations can interfere with other important communications.
- Always use your radio call sign at the beginning and end of each transmission.
- Be sure only qualified persons operate your radio. You are responsible for control of your radio. Know the rules.
- Limit calls to other vessels to 30 seconds. If you receive no reply, wait 2 minutes; then try again. Keep communications brief and avoid chit-chat.
- Never transmit false distress messages, and never use profanity on the air.

Other Reminders:

- You can obtain a station license and call sign by completing FCC Form 605 and mailing it with the required fee (if required) to the FCC.
- You need a radio operator license to operate a VHF Marine Radio only if you plan to dock in a foreign port or leave a foreign port to dock in a U.S. port.
- Your radio license is not transferable. If you sell your boat, request the FCC to cancel your station license.
- If you replace your radio, you do not need to change your license unless the new radio operates on another frequency band. If you install equipment to operate on another frequency band, apply for modification of your license.

5.2 Marine VHF Channel Usage Guide

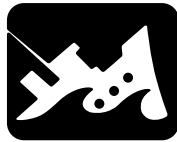

Emergency



Calling



Monitoring

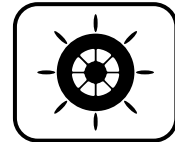

Intership Safety



U.S. Coast Guard

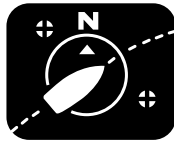

Navigation



Port Operation



Noncommercial



Commercial



Marine Operator



State Control



Environmental



Weather



Emergency

Channel 16

If:

- Your ship is sinking, or on fire
- Someone has been lost overboard
- There exists grave and imminent danger

Use this distress procedure:

- Select Channel 16
- Say "Mayday, Mayday, Mayday."
- Give call sign and boat name
- Give location of boat
- Describe emergency
- If no answer, repeat; then try another channel

Caution

Every ship at sea is to be obliged to give absolute priority to radio communications relating to ships in distress - it is vital that false distress calls or messages not be broadcast.



Calling

Channel 16, 9, and Working Channel

- | | |
|------|---|
| If | - you wish to establish communications with another station |
| And | - you know which working channel the station is monitoring |
| Then | - initiate the call directly on that working channel |
| If | - you wish to establish communications with another station |
| And | - you do not know what working channel the station may be monitoring |
| Then | - initiate the call on channel 16. After contact is made switch to a working channel. |

Note: Due to congestion on channel 16 caused by frequent hailing of other vessels, the FCC has approved channel 9 as a second hailing channel.

Avoid excessive calling and radio checks

Always monitor before transmitting

Never interrupt emergency communications



Monitoring

Channel 16 and Working Channel

When - your VHF station is turned on and it is not being used to exchange communications

You Must - monitor channel 16

As an operating convenience, many stations employ a second receiver so that they can monitor a working channel and channel 16 simultaneously.

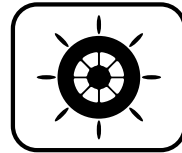

Intership Safety

Channel: 6

Vessels: Any

Use: Communicating navigational and weather warnings to other ships

Communicating with U.S. Coast Guard stations or other vessels during search and rescue operations

Between: Ship-to-ship only

Comments: Do not use for routine communications. This is a safety channel.



U.S. Coast Guard

Channel: 22A

Vessels: Any

Use: Working channel for exchange of communications with stations of the U.S. Coast Guard.

Between: Ship to U.S. Coast Guard ship, coast to aircraft stations

Comments: U.S. Coast Guard does not regularly monitor this channel. Establish contact on channel 16 and shift to channel 22A as directed.

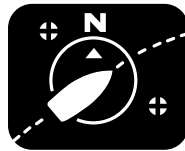

Navigation

Channel: 13

Vessels: Any

Use: Safety Communications pertaining to the maneuvering of vessels or the directing of vessel movements

Between: Ship-to ship and secondarily ship-to-coast

This is commonly called the Bridge-to-Bridge channel. Large vessels and towboats depend on this channel for their safe navigation. Railway or highway bridges which open for ship navigation often operate on this channel.

Bridge-to-Bridge stations must reduce power to one watt for routine operations.

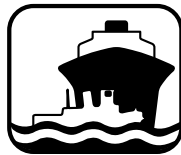

Port Operations

Channels: 1A, 5A, 12, 14, 20, 65A, 66A, 73, 74, 77

Vessels: Any

Use: Messages relating to the operational handling, movement and safety of vessels in or near ports, locks and waterways.

Between: Ship-to ship or ship-to-coast

Comments: Channel 77 is limited to communications to and from commercial pilots concerning the movement and docking of vessels.

Note: Channels 11, 12, 13 and 14 are used for vessels traffic service on the Great Lakes, St. Lawrence Seaway and designated major ports.



Non commercial (Boat Operations)

Channels: 9, 68, 69, 71, 72, 78A

Vessels: Recreational boats and any others not used primarily for commercial transport.

Use: Communications pertaining to the needs of the vessel (i.e., fishing, rendezvous, maneuvers, berthing, scheduling of repairs, provisioning, etc.)

Between: Ship-to-ship or ship to limited coast stations

Comments: Channel 72 may not be used for ship to coast communications. Channel 9 is shared with Commercial users.

If you regularly monitor one of these channels with a second receiver, please notify frequently-called stations of this practice. Help reduce congestion on channel 16.



Commercial

Channels: 7A, 8, 9, 10, 11, 18A, 19A, 67, 79A, 80A, 88A

Vessels: Those used primarily for commercial transport of persons or goods, or engaged in servicing other vessels

Use: Communications pertaining to the purpose for which the vessel is used

Between: Commercial transport vessels (ship-to-ship) or between commercial transport vessels and limited coast stations

Channel 8, 67 and 88A may not be used for ship-to-coast communications

Recreational boats are not permitted to use these channels



Marine Operator

Channels: 24, 25, 26, 27, 28, 84, 85, 86, 87A

Vessels: Any

Use: To place a telephone call to any location in the world or to a vessel outside of your transmitting range

Between: Vessels and public coast stations

Comments: Contact the marine operator on the channel assigned to your navigating area. If unable to determine this channel, use channel 16.

Be patient. Do not interrupt calls in progress. Avoid excessive calling if the operator does not answer - give the operator a chance to reply.

**State Control**

Channel: 17

Vessels: State and local government

Use: Coordination, regulation and control of boating activities and the rendering of assistance to vessels.

Between: Ship and coast stations associated with state and local governments.

**Environmental**

Channel: 15

Vessels: Any (receive only)

Use: Broadcast of information concerning the environmental conditions in which vessels operate - weather, sea conditions, time signals, notices to mariner, hazards to navigation

Between: One-way broadcast from coast to ship stations

Note: Currently used for Class C EPIRB emergency signals.

**Weather**

Channels: WX0—WX9

Vessels: Any

Use: Continuous weather information from NOAA (National Oceanic and Atmospheric Administration)

Between: One-way broadcast from NOAA to any interested parties

Comments: Receive only. You are not permitted to transmit on these frequencies.

PHONETIC ALPHABET:

To help make call letters more clearly understood, and to assist in spelling out similar sounding or unfamiliar words, radiotelephone users employ the international phonetic alphabet.

Phonetic Alphabet:

A - ALPHA
B - BRAVO
C - CHARLIE
D - DELTA
E - ECHO
F - FOX-TROT
G - GOLF
H - HOTEL
I - INDIA
J - JULIET
K - KILO
L - LIMA
M - MIKE
N - NOVEMBER
O - OSCAR
P - PAPA
Q - QUEBEC
R - ROMEO
S - SIERRA
T - TANGO
U - UNIFORM
V - VICTOR
W - WHISKEY
X - X-RAY
Y - YANKEE
Z - ZULU

5.3 VHF Marine Channels Frequency Tables

International Mode

Note: *International VHF frequency usage varies from country to country. Ensure you are familiar with the channel requirements of the country where you are boating before using any VHF transceiver.*

International Mode				
Channel Number	Frequency (MHz)		Type of Traffic	TX Power
	TX	RX		
01	156.050	160.650	Public Correspondence (Marine Operator)	Hi, Lo
02	156.100	160.700	Public Correspondence (Marine Operator)	Hi, Lo
03	156.150	160.750	Public Correspondence (Marine Operator)	Hi, Lo
04	156.200	160.800	Public Correspondence (Marine Operator)	Hi, Lo
05	156.250	160.850	Public Correspondence (Marine Operator), Port Operations, Ship Movement	Hi, Lo
06	156.300	156.300	Intership Safety	Hi, Lo
07	156.350	160.950	Public Correspondence (Marine Operator), Port Operations, Ship Movement	Hi, Lo
08	156.400	156.400	Intership	Hi, Lo
09	156.450	156.450	Intership, Port Operations, Ship Movement	Hi, Lo
10	156.500	156.500	Intership	Hi, Lo
11	156.550	156.550	Port Operations, Ship Movement	Hi, Lo
12	156.600	156.600	Port Operations, Ship Movement	Hi, Lo
13	156.650	156.650	Intership Navigation, Safety	Hi, Lo
14	156.700	156.700	Port Operations, Ship Movement	Hi, Lo
15 ¹	156.750	156.750	On Board Communications, Intership	Lo Only
16	156.800	156.800	International Distress, Safety	Hi, Lo
17 ¹	156.850	156.850	On Board Communications, Intership	Lo Only
18	156.900	161.500	Public Correspondence (Marine Operator), Port Operations, Ship Movement	Hi, Lo
19	156.950	161.550	Public Correspondence (Marine Operator), Port Operations, Ship Movement	Hi, Lo
20	157.000	161.600	Public Correspondence (Marine Operator), Port Operations, Ship Movement	Hi, Lo
21	157.050	161.650	Public Correspondence (Marine Operator), Port Operations, Ship Movement	Hi, Lo
22	157.100	161.700	Public Correspondence (Marine Operator), Port Operations, Ship Movement	Hi, Lo

Channel Number	Frequency (MHz)		Type of Traffic	TX Power
	TX	RX		
23	157.150	161.750	Public Correspondence (Marine Operator)	Hi, Lo
24	157.200	161.800	Public Correspondence (Marine Operator)	Hi, Lo
25	157.250	161.850	Public Correspondence (Marine Operator)	Hi, Lo
26	157.300	161.900	Public Correspondence (Marine Operator)	Hi, Lo
27	157.350	161.950	Public Correspondence (Marine Operator)	Hi, Lo
28	157.400	162.000	Public Correspondence (Marine Operator)	Hi, Lo
60	156.025	160.625	Public Correspondence (Marine Operator) Port Operations, Ship Movement	Hi, Lo
61	156.075	160.675	Public Correspondence (Marine Operator) Port Operations, Ship Movement	Hi, Lo
62	156.125	160.725	Public Correspondence (Marine Operator) Port Operations, Ship Movement	Hi, Lo
63	156.175	160.775	Public Correspondence (Marine Operator) Port Operations, Ship Movement	Hi, Lo
64	156.225	160.825	Public Correspondence (Marine Operator) Port Operations, Ship Movement	Hi, Lo
65	156.275	160.875	Public Correspondence (Marine Operator) Port Operations, Ship Movement	Hi, Lo
66	156.325	160.925	Public Correspondence (Marine Operator) Port Operations, Ship Movement	Hi, Lo
67	156.375	156.375	Intership, Port Operations	Hi, Lo
68	156.425	156.425	Port Operations, Ship Movement	Hi, Lo
69	156.475	156.475	Intership, Port Operations, Ship Movement	Hi, Lo
70 ²	—	—	DSC Communications Only	—
71	156.575	156.575	Port Operations, Ship Movement	Hi, Lo
72	156.625	156.625	Intership, Port Operations, Ship Movement	Hi, Lo
73	156.675	156.675	Intership, Port Operations, Ship Movement	Hi, Lo
74	156.725	156.725	Port Operations, Ship Movement	Hi, Lo
77	156.875	156.875	Intership	Hi, Lo
78	156.925	161.525	Public Correspondence, Port Operations	Hi, Lo
79	156.975	161.575	Public Correspondence, Port Operations	Hi, Lo
80	157.025	161.625	Public Correspondence, Port Operations	Hi, Lo
81	157.075	161.675	Public Correspondence, Port Operations	Hi, Lo
82	157.125	161.725	Public Correspondence, Port Operations	Hi, Lo
83	157.175	161.775	Public Correspondence, Port Operations	Hi, Lo
84	157.225	161.825	Public Correspondence, Port Operations	Hi, Lo
85	157.275	161.875	Public Correspondence, Port Operations	Hi, Lo
86	157.325	161.925	Public Correspondence, Port Operations	Hi, Lo

Channel Number	Frequency (MHz)		Type of Traffic	TX Power
	TX	RX		
87A	157.375	157.375	Public Correspondence, Port Operations	Hi, Lo
88A	157.425	157.425	Public Correspondence, Port Operations	Hi, Lo

Notes:

1. For channels 15 and 17, output power is fixed at 1 watt only. Transmission at high power is not permitted.
2. Channel 70 is used for Digital Selective Calling (DSC) only and is not available for voice transmissions. Channel 70 does not appear on the display.

Important Notice

The International frequency mode is not legal for use while operating in U.S. waters. The TX/RX frequencies available in International frequency mode were agreed upon by the attending countries at the 1968 ITU-International Telecommunication Union meeting in Geneva, and are legal for use in International waters only.

Canadian Mode Frequency Table

Canadian Mode				
Channel Number	Frequency (MHz)		Type of Traffic	TX Power
	TX	RX		
01	156.050	160.650	Public Correspondence (Marine Operator)	Hi, Lo
02	156.100	160.700	Public Correspondence (Marine Operator)	Hi, Lo
03	156.150	160.750	Public Correspondence (Marine Operator)	Hi, Lo
04A	156.200	156.200	Pacific Coast: Canadian Coast Guard East Coast: Commercial Fishing Only	Hi, Lo
05A	156.250	156.250	Ship Movement	Hi, Lo
06	156.300	156.300	Intership Safety	Hi, Lo
07A	156.350	156.350	Commercial	Hi, Lo
08	156.400	156.400	Commercial (Intership Safety)	Hi, Lo
09	156.450	156.450	Boater Calling Channel, Commercial and Non-Commercial	Hi, Lo
10	156.500	156.500	Ship Movement, Commercial and Non-Commercial (Intership Safety)	Hi, Lo
11	156.550	156.550	Port Operations, Ship Movement	Hi, Lo
12	156.600	156.600	Port Operations, Ship Movement	Hi, Lo
13 ¹	156.650	156.650	Intership Navigation (Bridge to Bridge)	Lo
14	156.700	156.700	Port Operations, Ship Movement	Hi, Lo
15 ²	156.750	156.750	On Board Communications	Lo Only
16	156.800	156.800	International Distress, Safety, and Calling	Hi, Lo
17 ²	156.850	156.850	On Board Communications	Lo Only
18A	156.900	156.900	Commercial, Towing on Pacific Coast	Hi, Lo
19A	156.950	156.950	Canadian Coast Guard Only	Hi, Lo
20	157.000	161.600	Port Operation with 1 watt max. power	Hi, Lo
21A	157.050	157.050	Canadian Coast Guard Only	Hi, Lo
22A	157.100	157.100	Communication between Canadian Coast Guard and non-Canadian Coast Guard	Hi, Lo
23	157.150	161.750	Public Correspondence on Pacific Coast and Inland Waters of BC and the Yukon	Hi, Lo
24	157.200	161.800	Public Correspondence in all areas	Hi, Lo
25	157.250	161.850	Public Correspondence on Pacific Coast and Lake Winnipeg	Hi, Lo
26	157.300	161.900	Public Correspondence, Safety	Hi, Lo
27	157.350	161.950	Public Correspondence on Pacific Coast, Atlantic Coast, and Great Lakes	Hi, Lo

Channel Number	Frequency (MHz)		Type of Traffic	TX Power
	TX	RX		
28	157.400	162.000	Public Correspondence on Pacific Coast	Hi, Lo
60	156.025	160.625	Public Correspondence	Hi, Lo
61A	156.075	156.075	Pacific Coast: Canadian Coast Guard East Coast: Commercial Fishing Only	Hi, Lo
62A	156.125	156.125	Pacific Coast: Canadian Coast Guard East Coast: Commercial Fishing Only	Hi, Lo
64A	156.225	156.225	East Coast: Commercial Fishing	Hi, Lo
65A	156.275	156.275	Great Lakes: Search & Rescue Antipollution Operations Pacific Coast: Towing St. Lawrence River Area: Port Operations (restricted to 1 watt)	Hi, Lo
66A	156.325	156.325	St. Lawrence River / Great Lakes Areas: Port Operations Only (restricted to 1W)	Hi, Lo
67	156.375	156.375	Search & Rescue, Antipollution Operations East Coast Only: Commercial Fishing	Hi, Lo
68	156.425	156.425	Non-Commercial, Marinas & Yacht Clubs	Hi, Lo
69	156.475	156.475	Commercial and Non-Commercial East Coast Only: Commercial Fishing	Hi, Lo
70 ³	—	—	DSC Communications Only	—
71	156.575	156.575	Commercial and Non-commercial	Hi, Lo
72	156.625	156.625	Maritime Support Operation	Hi, Lo
73	156.675	156.675	Search & Rescue, Antipollution Operations East Coast Only: Commercial Fishing	Hi, Lo
74	156.725	156.725	Ship Movement	Hi, Lo
77 ²	156.875	156.875	Ship Movement, Intership Safety	Lo Only
78A	156.925	156.925	Commercial	Hi, Lo
79A	156.975	156.975	Commercial	Hi, Lo
80A	157.025	157.025	Commercial	Hi, Lo
81A	157.075	157.075	Canadian Coast Guard Only	Hi, Lo
82A	157.125	157.125	Canadian Coast Guard Only	Hi, Lo
83A	157.175	157.175	Canadian Coast Guard Only	Hi, Lo
84	157.225	161.825	Public Correspondence (Marine Operator)	Hi, Lo
85	157.275	161.875	Public Correspondence (Marine Operator)	Hi, Lo
86	157.325	161.925	Public Correspondence (Marine Operator)	Hi, Lo
87	157.375	161.975	Public Correspondence (Marine Operator)	Hi, Lo
88	157.425	162.025	Public Correspondence (Marine Operator)	Hi, Lo

Important Notice

The Canadian frequency mode is not legal for use while operating in U.S. waters.

Notes:

1. *For channel 13, output power is fixed at 1 watt (low power) by regulation. In an emergency, you can override to high power by pressing and holding PTT and then pressing the MON/1/25 key on the base station. Output power is increased to 25 watts while both keys are pressed. After MON/1/25 is released, power returns to 1 watt.*
2. *For channels 15, 17, and 77, output power is fixed at 1 watt only. Transmission at high power is not permitted.*
3. *Channel 70 is used for Digital Selective Calling (DSC) only and is not available for voice transmissions. Channel 70 does not appear on the display.*

US Mode Frequency Table

US MODE				
Channel Number	Frequency (MHz)		Type of Traffic	TX Power
	TX	RX		
01A	156.050	156.050	Port Operations and Commercial, VTS in selected areas	Hi, Lo
03A	156.150	156.150	US Government and Coast Guard	Hi, Lo
05A	156.250	156.250	Port Operations, VTS in selected areas	Hi, Lo
06	156.300	156.300	Intership Safety	Hi, Lo
07A	156.350	156.350	Commercial	Hi, Lo
08	156.400	156.400	Commercial (Intership only)	Hi, Lo
09	156.450	156.450	Boater Calling, Commercial and non-Commercial	Hi, Lo
10	156.500	156.500	Commercial	Hi, Lo
11	156.550	156.550	Commercial, VTS in selected areas	Hi, Lo
12	156.600	156.600	Port Operations, VTS in selected areas	Hi, Lo
13 ¹	156.650	156.650	Intership Navigational Safety (Bridge to Bridge)	Lo
14	156.700	156.700	Port Operations, VTS in selected areas	Hi, Lo
15 ²	—	156.750	Environmental (Receive only)	—
16	156.800	156.800	International Distress, Safety, and Calling	Hi, Lo
17 ³	156.850	156.850	State Controlled	Lo only
18A	156.900	156.900	Commercial	Hi, Lo
19A	156.950	156.950	Commercial	Hi, Lo
20A	157.000	157.000	Port Operations	Hi, Lo
21A	157.050	157.050	Coast Guard only	Hi, Lo
22A	157.100	157.100	Coast Guard Liason and Maritime Safety Info. Broadcasts announced on CH 16.	Hi, Lo
23A	157.150	157.150	Coast Guard only	Hi, Lo
24	157.200	161.800	Public Correspondence (Marine Operator)	Hi, Lo
25	157.250	161.850	Public Correspondence (Marine Operator)	Hi, Lo
26	157.300	161.900	Public Correspondence (Marine Operator)	Hi, Lo
27	157.350	161.950	Public Correspondence (Marine Operator)	Hi, Lo
28	157.400	162.000	Public Correspondence (Marine Operator)	Hi, Lo
61A	156.075	156.075	US Government and Canadian Coast Guard	Hi, Lo
63A	156.175	156.175	Port Operations and Commercial. VTS in selected areas.	Hi, Lo
64A	156.225	156.225	US Government	Hi, Lo
65A	156.275	156.275	Port Operations	Hi, Lo

Channel Number	Frequency (MHz)		Type of Traffic	TX Power
	TX	RX		
66A	156.325	156.325	Port Operations	Hi, Lo
67 ¹	156.375	156.375	Commercial, Bridge-to-Bridge (Intership)	Lo only
68	156.425	156.425	Non-Commercial	Hi, Lo
69	156.475	156.475	Non-Commercial	Hi, Lo
70 ⁴	—	—	DSC Communications Only	—
71	156.575	156.575	Non-Commercial	Hi, Lo
72	156.625	156.625	Non-Commercial (Intership Only)	Hi, Lo
73	156.675	156.675	Port Operations	Hi, Lo
74	156.725	156.725	Port Operations	Hi, Lo
77 ³	156.875	156.875	Port Operations (Intership Only)	Lo only
78A	156.925	156.925	Non-Commercial	Hi, Lo
79A	156.975	156.975	Commercial	Hi, Lo
80A	157.025	157.025	Commercial	Hi, Lo
81A	157.075	157.075	US Government Only: Environmental Protection Operations	Hi, Lo
82A	157.125	157.125	US Government Only	Hi, Lo
83A	157.175	157.175	US Coast Guard Only	Hi, Lo
84	157.225	161.825	Public Correspondence (Marine Operator)	Hi, Lo
85	157.275	161.875	Public Correspondence (Marine Operator)	Hi, Lo
86	157.325	161.925	Public Correspondence (Marine Operator)	Hi, Lo
87	157.375	161.975	Public Correspondence (Marine Operator)	Hi, Lo
88A	157.425	157.425	Commercial (Intership Only)	Hi, Lo

Notes:

1. For channels 13 and 67, output power is fixed at 1 watt (low power) by regulation. In an emergency, you can override to high power by pressing and holding PTT and then pressing the MON/ 1/25 key on the base station. Output power is increased to 25 watts while both keys are pressed. After MON/1/25 is released, power returns to 1 watt.
2. Channel 15 is receive only. Transmission is not permitted.
3. For channels 17 and 77, output power is fixed at 1 watt only. Transmission at high power is not permitted.
4. Channel 70 is used for Digital Selective Calling (DSC) only and is not available for voice transmissions. Channel 70 does not appear on the display.

Important Notice

Channels 3A, 21A, 23A, 61A, 64A, 81A, 82A, and 83A (shaded) are not for use by the general public in U.S. waters. These frequencies may be used only under authorization by the U.S. Coast Guard or under private land mobile license.

Weather Channels and Frequencies

CH	RX Frequency	Type of Traffic	Transmission Type
1	162.550	Weather	Receive only
2	162.400	Weather	Receive only
3	162.475	Weather	Receive only
4	162.425	Weather	Receive only
5	162.450	Weather	Receive only
6	162.500	Weather	Receive only
7	162.525	Weather	Receive only
8	161.650	Weather	Receive only
9	161.775	Weather	Receive only
0	163.275	Weather	Receive only

Ray230 Ray230e

Document Number: R49006



Raymarine Ltd.
Anchorage Park
Portsmouth, Hampshire
England PO3 5TD
+44 (0)23 9269 3611
+44 (0)23 9269 4642 fax
www.raymarine.com

Raymarine Inc.
22 Cotton Road, Unit D
Nashua, NH 03063-4219
USA
603-881-5200
603-864-4756 fax
www.raymarine.com

Raymarine
ON BOARD

